

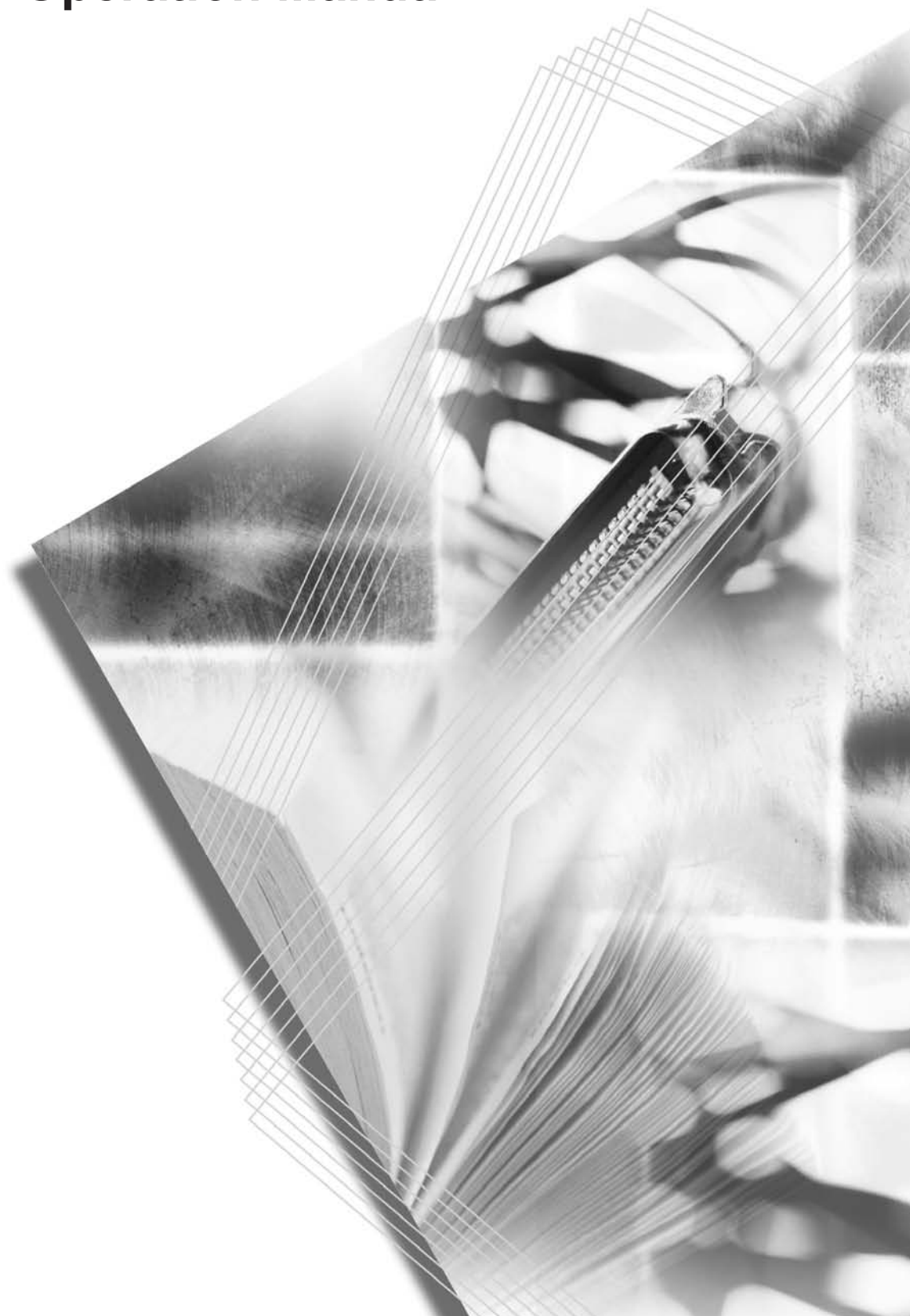

KM-3650w

# General Operation Manual



Please read the General Operation Manual before using this machine. Keep it close to the machine for easy reference.

# TABLE OF CONTENTS

## Chapter 1 Before Use

---

	Page
<b>1.1 Originals Prohibited from Duplication</b> .....	1- 2
<b>1.2 Features</b> .....	1- 3
<b>1.3 Specifications</b> .....	1- 4
1.3.1 General .....	1- 4
1.3.2 Printer part .....	1- 5
1.3.3 Scanner part .....	1- 6
<b>1.4 Appearance</b> .....	1- 7
1.4.1 Front view .....	1- 7
1.4.2 Rear view .....	1- 8
<b>1.5 Specifications for the Scan Original</b> .....	1- 9
<b>1.6 Specifications for the Printing Paper</b> .....	1- 12
1.6.1 Papers not available to use .....	1- 12
1.6.2 Keeping the paper in the custody .....	1- 13
1.6.3 Measures against environmental condition .....	1- 14

## Chapter 2 Basic Operations

---

	Page
<b>2.1 Turning on the Machine</b> .....	2- 2
<b>2.2 Turning off the Machine</b> .....	2- 3
<b>2.3 Replacement of Roll Paper</b> .....	2- 4
<b>2.4 Replacement of Toner Cartridge</b> .....	2- 9
<b>2.5 Set of Cut Sheet Paper to the Bypass Feeder</b> .....	2- 13
<b>2.6 Copying</b> .....	2- 14
<b>2.7 Emergent Stop of Scan or Copy</b> .....	2- 15
<b>2.8 Dehumidifying the Roll Paper (Option)</b> .....	2- 16

## Chapter 3 Error Correction

---

	Page
<b>3.1 Operator Call Errors</b> .....	3- 2
3.1.1 Paper jam .....	3- 2
3.1.1.1 Paper jam in the Roll Deck. Set the roll paper correctly. ....	3- 2
3.1.1.2 Paper jam in the bypass feeder. Remove the paper. ....	3- 5
3.1.1.3 Paper jam in internal area. Open the cover, and remove the paper. ....	3- 6
3.1.1.4 Paper jam in exit area. Open the cover, and remove the paper. ....	3- 8
3.1.1.5 Original Jam. Open the cover, and remove the original. ....	3- 11
3.1.2 Open errors .....	3- 12
3.1.2.1 Cover is open. Close the Cover. or Printer is starting up. ....	3- 12

3. 1. 2. 2	Roll Deck is open. Close the Roll Deck. ....	3- 14
3. 1. 2. 3	Close the scanner cover. ....	3- 15
3. 1. 3	Other messages ....	3- 16
3. 1. 3. 1	Set XX roll paper to the Roll Deck. ....	3- 16
3. 1. 3. 2	Set a paper to the bypass feeder. ....	3- 16
3. 1. 3. 3	Toner empty. Replace the toner cartridge. ....	3- 17
3. 1. 3. 4	In Warm Sleep Mode ....	3- 17
3. 1. 3. 5	In Power Save Mode ....	3- 18
<b>3. 2</b>	<b>Service Call Errors</b> .....	<b>3- 19</b>

## **Chapter 4 Maintenance**

---

<b>4. 1</b>	<b>Cleaning of Each Part</b> .....	<b>Page</b> 4- 2
4. 1. 1	Scanner Unit .....	4- 2
4. 1. 2	Print Engine .....	4- 4
4. 1. 3	Operation Panel .....	4- 6

# Chapter 1

## Before Use

	Page
<b>1.1 Originals Prohibited from Duplication</b> .....	1- 2
<b>1.2 Features</b> .....	1- 3
<b>1.3 Specifications</b> .....	1- 4
1.3.1 General .....	1- 4
1.3.2 Printer part .....	1- 5
1.3.3 Scanner part .....	1- 6
<b>1.4 Appearance</b> .....	1- 7
1.4.1 Front view .....	1- 7
1.4.2 Rear view .....	1- 8
<b>1.5 Specifications for the Scan Original</b> .....	1- 9
<b>1.6 Specifications for the Printing Paper</b> .....	1- 12
1.6.1 Papers not available to use .....	1- 12
1.6.2 Keeping the paper in the custody .....	1- 13
1.6.3 Measures against environmental condition .....	1- 14

# 1.1 Originals Prohibited from Duplication

Some kind of original is not allowed to copy.

You may be punished by the law if only you possess the copy of some kind of original.

We recommend you to consider enough before you copy such original.

[Originals prohibited from copying by the law]

1. Currency (Bill, Money, Bank Note, etc.) or Government issued Negotiable Instruments (National Bonds, Security, Local Debt Bonds, etc.) are prohibited from copying.
2. Foreign Currency or Foreign Negotiable Instruments are prohibited from copying.
3. Without permission to make replica from Government, unused postal stamps or government postcards are prohibited from copying.
4. Government issued revenue stamps, or certificate stamps which are prescribed by Liquor Tax Act or the Commodity Tax Act are prohibited from copying.

[Special items to be cared]

1. Government warns to copy private issued securities (stock certificate, draft, check, goods ticket, etc.), commutation ticket or book of tickets, excluding that some specific company copies such originals as many as it requires for its own business.
2. We recommend you not to copy freely such originals as government issued passport, public or private issued licenses, automobile inspection certification, IDs and tickets like pass or meal.

Reference Law	Prohibited items to copy
Regulations to control fake currency and Bond.	Currency (Bill, Money, Bank Note, etc.), Government issued Negotiable Instruments (National Bonds, Security, Local Debt Bonds, etc.)
Control Law against Forged & faked Foreign Currency, Bill, Bank Note and Bond	Foreign Currency or Foreign Negotiable Instruments
Forged postal stamps control law	Unused postal stamps or government postcards
Forged revenue stamps control law	Government issued revenue stamps, and certificate stamps prescribed by Liquor Tax Act or Commodity Tax Act
Currency similarity securities Control Law	Private issued securities (stock, draft, check, goods ticket, etc.), commutation or book tickets

[Originals protected by the copyright]

Except for personnel or family use or similar purpose, such originals as book, music, paintings, printed copy, maps, drawings, movie and pictures are prohibited from copying because these items are protected by the copyright.

## 1.2 Features

---

- (1) KM-3650w is a Multi-Function Printer which is available for scan, copy and print.
- (2) The operation speed is 60mm per second.  
(Metric) ..... -  
(Inch) ..... 2.6ppm/E 4.4ppm/D Landscape
- (3) The maximum print width is 914mm (36 inches) wide, and the minimum one is 279mm or 11".  
The maximum print length is 3600mm (in case of 36" paper), and the minimum one is 210mm or 8.5".
- (4) 600dpi Print Head and optimum Image Process System realize the highest image quality.
- (5) The print image is more stabilized by adoption of minute toner for mono-component development.
- (6) The combination of a unique development system and mono-component minute toner can produce a high definition line, distinctive greyscale and consistent solid black.  
100% of toner can be used as this development system generates no Waste Toner.

# 1.3 Specifications

---

## 1.3.1 General

Subject	Specification
Model	KM-3650w
Configuration	Console
Maximum power consumption	1500W (Including Scanner, Controller Unit and every option)
Acoustic noise	Idling ..... Max. 54db Printing ..... Max. 60db Impulse sound ..... Max. 65db EN ISO7779
Ozone	Max. 0.1ppm (Measurement method under UL Standard)
Dimensions	1525mm (Width) x 746mm (Depth) x 1230mm (Height) (Angle of Operation Panel is 45 degrees and trays are installed.)
Weight	About 210kg (1 roll) About 217kg (2 roll)
Environmental condition for usage	(Temperature) 10 to 32 degrees Centigrade (Humidity) 20 to 85% RH
Interface	Network Interface (10 BASE-T / 100 BASE-TX)
Input power	In U.S.A. : 120V plus/minus 10%, 60Hz, 15A In Europe : 220-240V plus 6% or minus 10%, 50Hz, 10A

 **NOTE**

The above specifications may change without notice.

## 1. 3. 2 Printer part

Subject	Specification
Printing method	LED Array Electro photography
Photoreceptor	Organic Photoconductive Drum
Print speed	60mm per second (Metric) ..... - (Inch) ..... 2.6ppm/E 4.4ppm/D Landscape
Print head	LED Array
Resolution of print head	600dpi x 600dpi
Print width	Maximum ..... 914mm (36 inches) Minimum ..... 297mm or 11" (Roll paper) ..... 210mm (Cut sheet paper)
Print length	Maximum Plain paper ..... 3600mm (36" paper) Or "3 x each standard length" (34" or narrower) Tracing ..... 2 x each standard length Film ..... 1 x each standard length  Minimum ..... 210mm  <div style="border: 1px solid black; padding: 5px;"> <p><b>! NOTE</b></p> <p>A longer print than the above lengths is available optionally. (24 meters max.) But note that we will not guarantee the image quality or reliability of paper feeding if the print is longer than the above lengths.</p> </div>
Warm up time	Shorter than 5 minutes (At 23°C, 60%RH, the rated voltage, and plain paper is used)
First print time	24 seconds (D Landscape / 100% / Roll1)
Fusing method	Heat and Pressure Rollers
Development method	Dry type non-magnetic mono-component toner
Media	(Recommended Media) Plain Paper ..... 64 to 80g/m <sup>2</sup> US Bond (PB-20) Tracing Paper ..... US Vellum (XV-20) Film ..... 4MIL (PF4DME)
Storage of consumables	(Toner cartridge) Store the cartridge within the temperature range from 0 to 35 degrees Centigrade and within the humidity range from 10 to 85% RH.

### **! NOTE**

The above specifications may change without notice.



### 1. 3. 3 Scanner part

Subject	Specification
Reading sensor	Contact Image Sensor (CIS) (5 pieces of A4 sized CIS)
Light source	LED
Scanning speed	65mm/sec.
Setting of original	Face up
Starting point of scan	Center
Scan width	Max. : 914mm (36") Min. : 279.0mm (11")
Scan length	Max. : 3,600mm Min. : 210mm (8.3")
Margin area	3mm from leading, trailing and both side edges
Optical resolution	600dpi
Digital resolution	600, 400, 300, 200, 100dpi
Original transportation	Sheet through type
Transportable original thickness	Max. : 0.60mm Min. : 0.05mm

**! NOTE**

If the thickness is thinner than 1.6mm, it can be transported. But we will not guarantee the image quality and reliability of original transportation.

**! NOTE**

The above specifications may change without notice.

# 1.4 Appearance

## 1.4.1 Front view

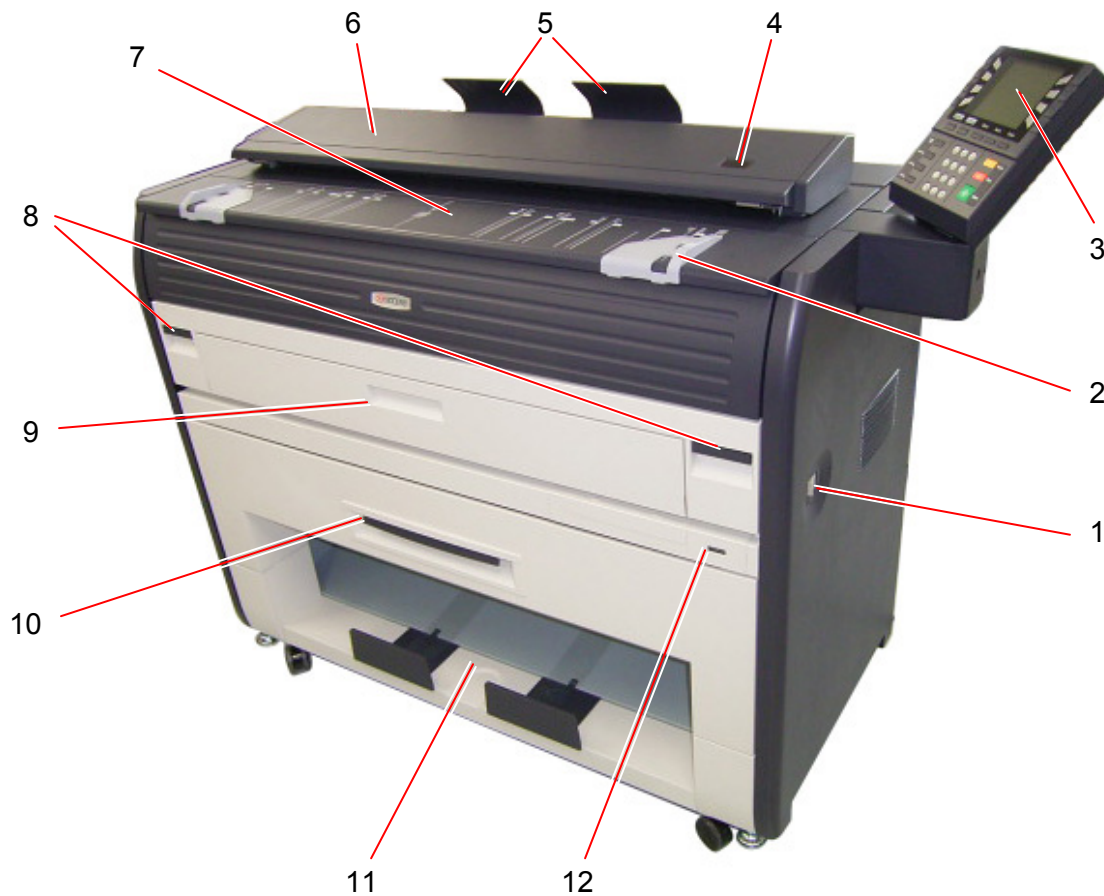

No.	Name	Function
1	Main Switch	Turns on/off the machine.
2	Original Guides	Guides the original to the Scanner Unit straight.
3	Operation Panel	Makes copy/scan operations.
4	Emergent Stop Button	Stops copying or scanning emergently.
5	Original Tray	Receives the original ejected from the Scanner Unit.
6	Scanner Unit	Reads the image pattern of original in scan and copy.
7	Toner Hatch (Original Table)	Open the Toner Hatch (Original Table) to access the Toner Cartridge. Put the original here and feed it into the Scanner Unit in scan or copy.
8	Engine Unit Open Lever	Opens the Engine Unit.
9	Bypass Feeder	Feeds a cut sheet paper.
10	Roll Deck	Holds the roll paper. (1 roll paper can be set normally. 2 roll papers are available is optional Roll Deck 2 is provided.)
11	Print Tray	Receives the prints (copies) ejected from the Copy Exit.
12	Counter	Counts the total amount of prints.

## 1. 4. 2 Rear view

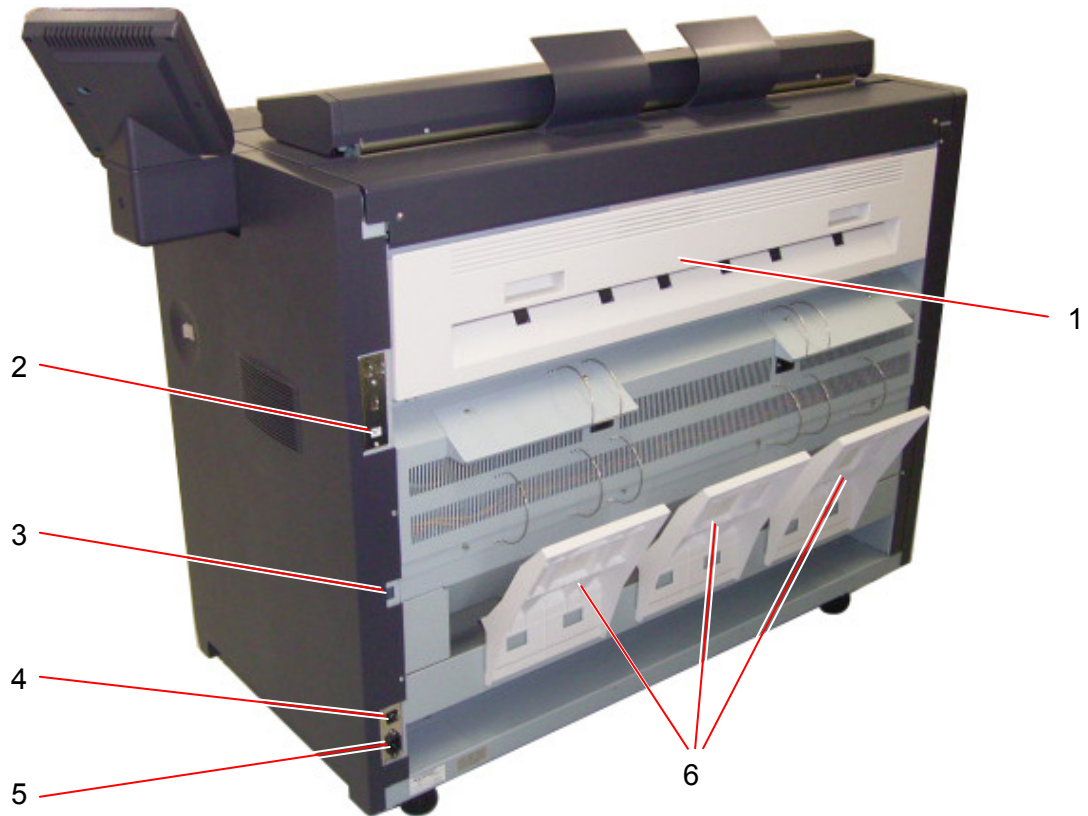

No.	Name	Function
1	Exit Cover	Open the Exit Cover to access the paper jam.
2	LAN Port	Connects the KM-3650w to the network. (Do not connect telephone line.)
3	Dehumidify Heater Switch (Option)	Turns on the Dehumidify Heater.
4	Inlet Socket	Connect the Power Cord.
5	Breaker	Shuts off the AC power.
6	Print Guide Trays	Guide the prints to the Print Tray.

# 1.5 Specifications for the Scan Original

A scan original must satisfy the following specifications.

Thickness	0.05mm to 0.6mm
Width	279.4mm to 914.4mm (11" to 36")
Length	210mm to 3,600mm

Do not scan the following kinds of original, because you may damage the original or scanner itself!

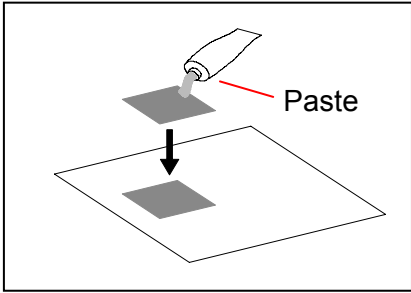
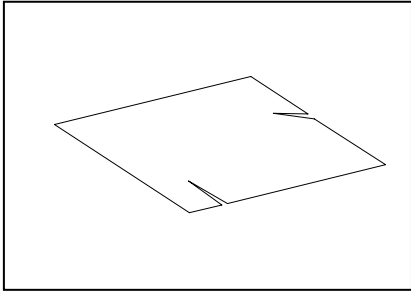
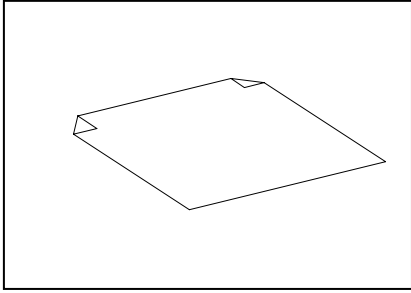
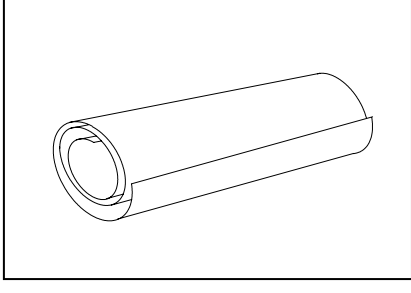
Sticked with paste	
Torn	
Folded (Leading edge)	
So much curled (Diameter is smaller than 50mm.)	

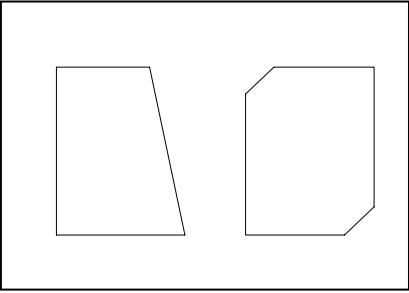
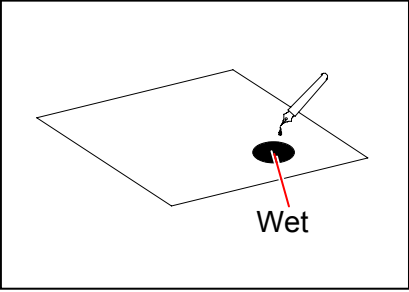
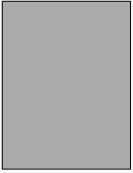
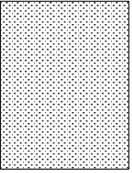
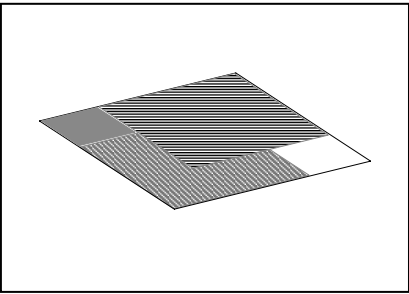
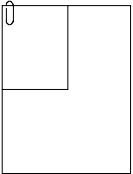
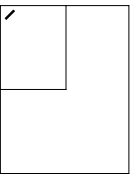
Not square	
Wet image	
Made of metal or fabric	<div style="display: flex; justify-content: space-around; align-items: center;"> <div style="text-align: center;"> <p>Metal</p>  </div> <div style="text-align: center;"> <p>Fabric</p>  </div> </div>
Patched	
Clipped or stapled	<div style="display: flex; justify-content: space-around; align-items: center;"> <div style="text-align: center;"> <p>Clipped</p>  </div> <div style="text-align: center;"> <p>Stapled</p>  </div> </div>

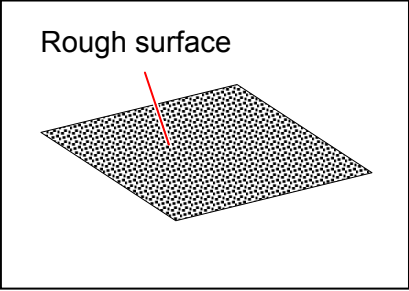
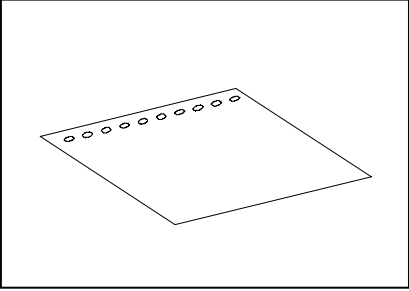
<p>Rough surface (Carbon paper for example)</p>	<p>Rough surface</p> 
<p>Punched</p>	

# 1. 6 Specifications for the Printing Paper

## 1. 6. 1 Papers not available to use

Do not use the following kinds of printing paper because you may damage the print engine!

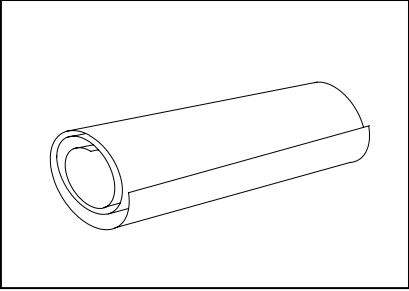
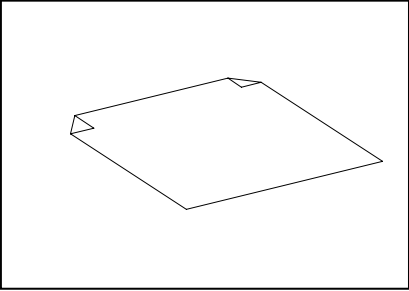
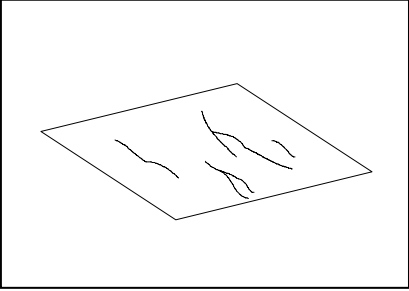
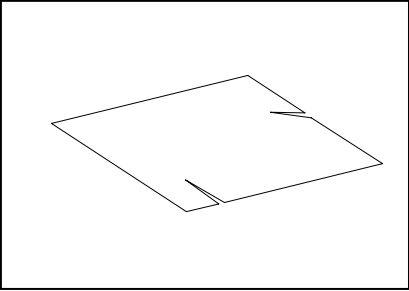
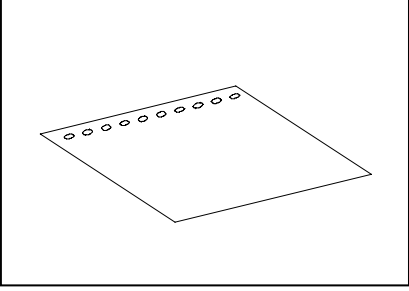
So much curled paper	
Folded paper	
Creased paper	
Torn paper	
Punched paper	

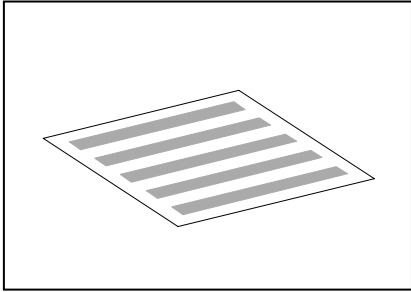
Paper that has already been used for printing	
Very slippery paper	
Very sticky paper	
Very thin and soft paper	
OHP Film	

### **! CAUTION**

Do not use the paper with staple, or do not use such conductive paper as aluminium foil and carbon paper.

Such paper may become cause for the fire.

### **! NOTE**

- (1) Print image may become light if printed on a paper of rough surface.
- (2) Print image may become defective if the print paper is much curled.
- (3) It will become a cause for paper jam, poor quality image or crease of paper if you use a paper that does not satisfy the specification.
- (4) Do not use a paper of which surface is very special, such as thermal paper, art paper, aluminium foil, carbon paper and conductive paper.

## **1. 6. 2 Keeping the paper in the custody**

Keep the paper in the custody taking care of the following matters.

1. Do not expose the paper to the direct sunlight.
2. Keep the paper away from high humidity. (It must be less than 70%)
3. Put the paper on a flat place
4. If you keep the paper in the custody, which you have already unpacked, put it into the polyethylene bag to avoid the humidity.



## 1. 6. 3 Measures against environmental condition

Take measures to meet with the environmental condition as shown below.

Humidity (%)	Possible problem	Measures
Low ↑	“Void of image”, “crease of paper” and other problems occurs when you print with plain paper and tracing paper.	1. Install the humidifier in the room, and humidify the room air. 2. Remove the paper from the machine right after the completion of print, and keep it in a polyethylene bag.
40%	“Void of image” occurs when you print with tracing paper.	If you will not make print soon, remove the tracing paper from the machine and keep it in a polyethylene bag.
		Remove the paper from the machine after everyday use, and keep it in a polyethylene bag.
70%	“Void of image” occurs when you print with plain paper and tracing paper.	If you will not make print soon, remove the tracing paper from the machine and keep it in a polyethylene bag.
↓ High	“Void of image”, “crease of paper” and other problems occurs when you print with plain paper and tracing paper.	1. Turn on the Dehumidify Heater of the KM-3650w. 2. Remove the paper from the machine right after the completion of print, and keep it in a polyethylene bag.

### ⚠ NOTE

- (1) The machine is not equipped with the Dehumidify Heater initially as it is an optional part. (You need to purchase it separately.)  
Turn it on when the humidity is higher than 65%.  
Refer to [2. 8 Dehumidifying the Roll Paper (Option)] on page 2-18 for the detail.
- (2) “Void of image” and “crease of paper” are the most popular problem you will encounter when the humidity condition is very high or very low.

Normal Print

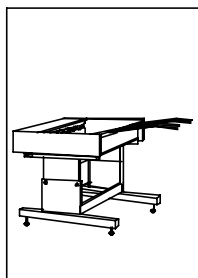

If the media is humidified ;

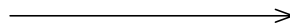

Crease of paper

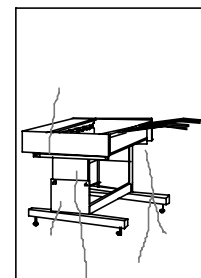

Normal Print

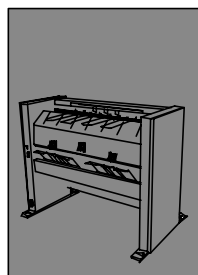

If the media is humidified ;



Void of image

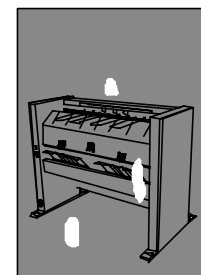

# Chapter 2

## Basic Operations

	Page
<b>2.1 Turning on the Machine</b> .....	2- 2
<b>2.2 Turning off the Machine</b> .....	2- 3
<b>2.3 Replacement of Roll Paper</b> .....	2- 4
<b>2.4 Replacement of Toner Cartridge</b> .....	2- 9
<b>2.5 Set of Cut Sheet Paper to the Bypass Feeder</b> .....	2- 13
<b>2.6 Copying</b> .....	2- 14
<b>2.7 Emergent Stop of Scan or Copy</b> .....	2- 15
<b>2.8 Dehumidifying the Roll Paper (Option)</b> .....	2- 16

## 2. 1 Turning on the Machine

1. Plug the machine into an exclusive wall outlet.

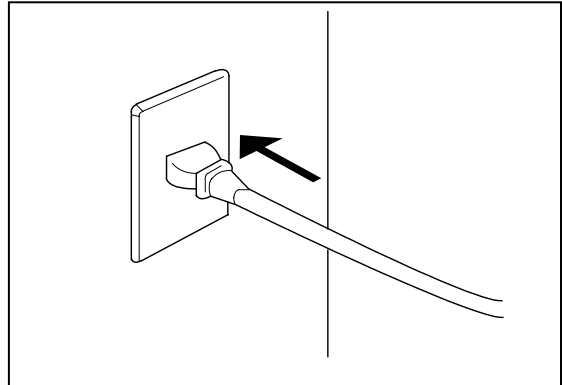

### **⚠ WARNING**

- (1) Do not handle the Power Plug with wet hands, or you may receive an electrical shock.
- (2) Make sure to earth the machine for your safety.
- (3) Do not plug the printer into a multi-wiring connector in which other devices are plugged. It may overheat the outlet and may result in a fire.
- (4) The outlet must satisfy the following conditions.
  - In U.S.A. : 120V, plus/minus 10%, 50/60Hz and 15A
  - In Europe : 220-240V plus 6% or minus 10%, 50/60Hz and 10A

2. Press the Power Switch on the right side of the KM-3650w to turn on the machine.



Power Switch

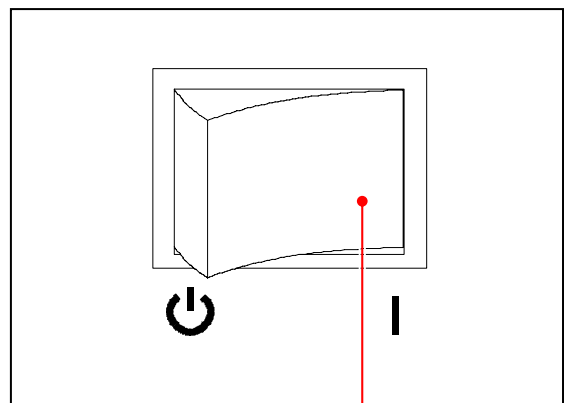

Press this side.

3. The Ready Indicator lights when the KM-3650w gets ready.  
Make scan, copy or print when it gets ready

### **⚠ NOTE**

Scan function is option.

## 2. 2 Turning off the Machine

---

1. Press the Power Switch on the right side of the KM-3650w to turn off the machine.



Power Switch

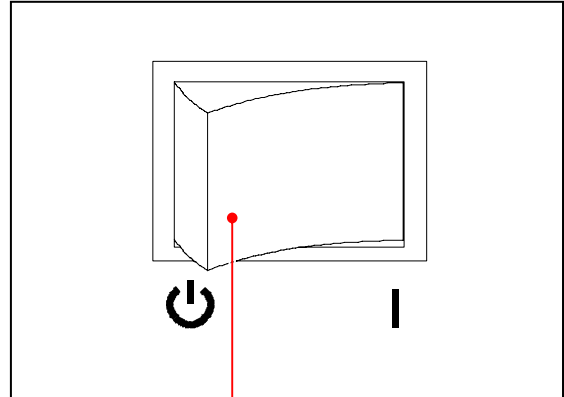

Press this side.

### CAUTION

**Do not unplug the KM-3650w for 1 minute after turning it off.  
The Controller Unit requires 1 minute to completely shut down after you switch off the KM-3650w.**

## 2. 3 Replacement of Roll Paper

Roll 2 is an optional part.  
The machine is equipped with the Roll 2 in the following instruction.

### **NOTE**

Note that a paper jam tends to occur at the time of roll end.

1. Pull up the Lever (1) and draw out the Roll Deck (2).

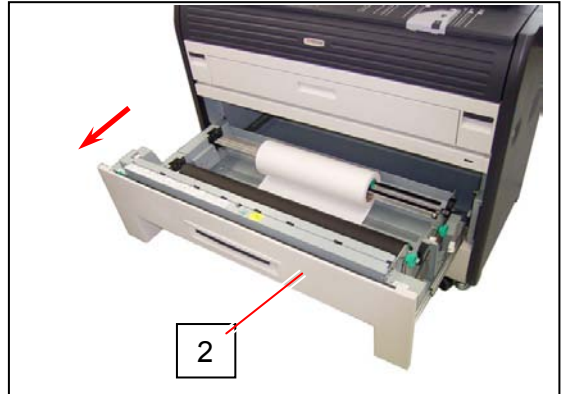

2. Remove the Roll Spool (3) with paper core from the Roll Deck.

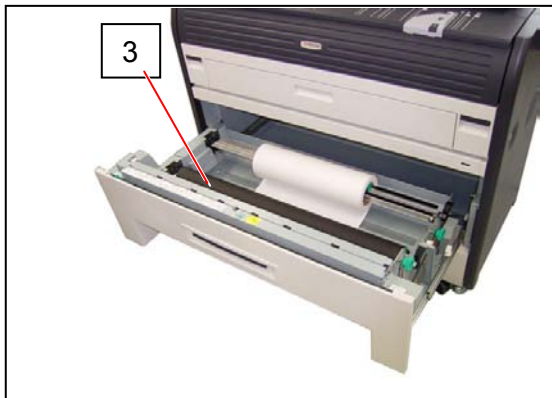

### **NOTE**

Confirm that the machine has finished the printing operation completely before opening the Roll Deck.  
If you open it during printing, a paper jam may occur.

3. Press down the Lever (4) to release the paper core, and then pull out the Roll Spool (3) from the paper core.

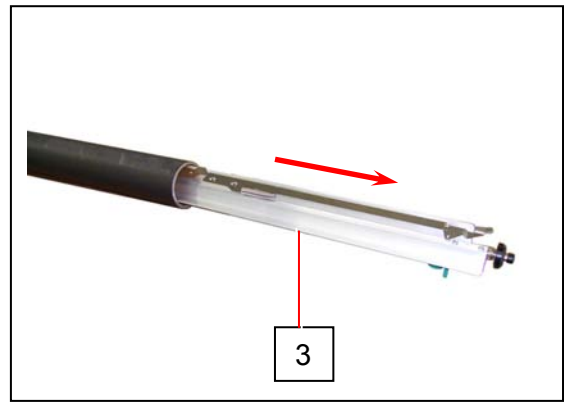
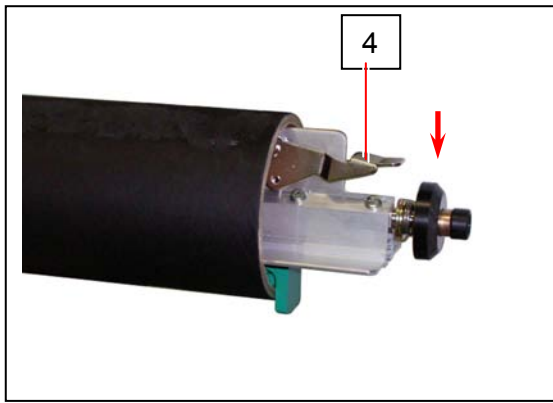

4. Loosen the knob (5), slide the position of Paper Guide (6) according to the width of roll paper you will set, and then fix the Paper Guide (6) tightening the knob (5).

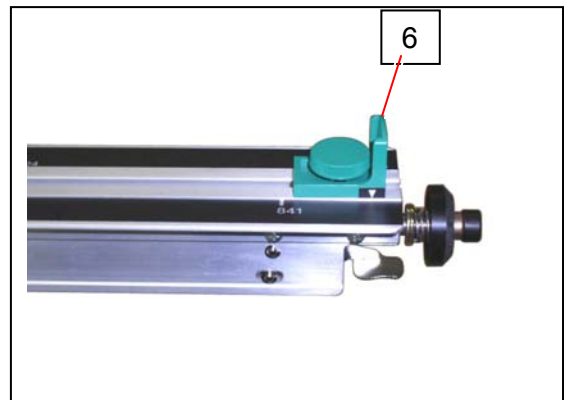
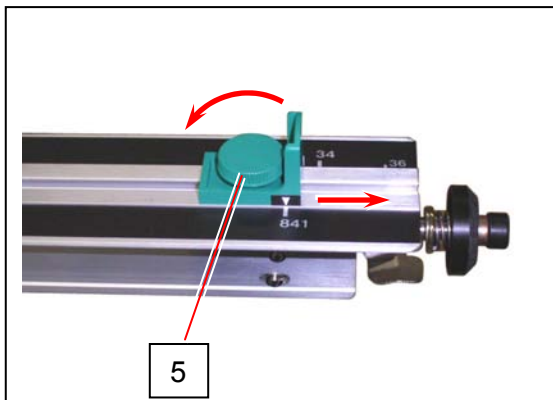

### ! NOTE

Align the triangle mark (7) of the Paper Guide with each size guide (8).

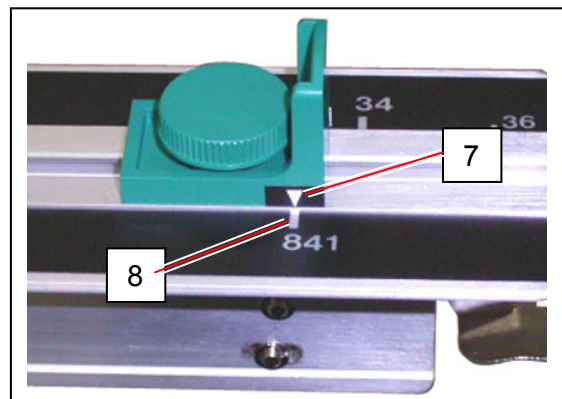

5. Pressing down the Lever (4), insert the Roll Spool (3) to the core of new roll paper.

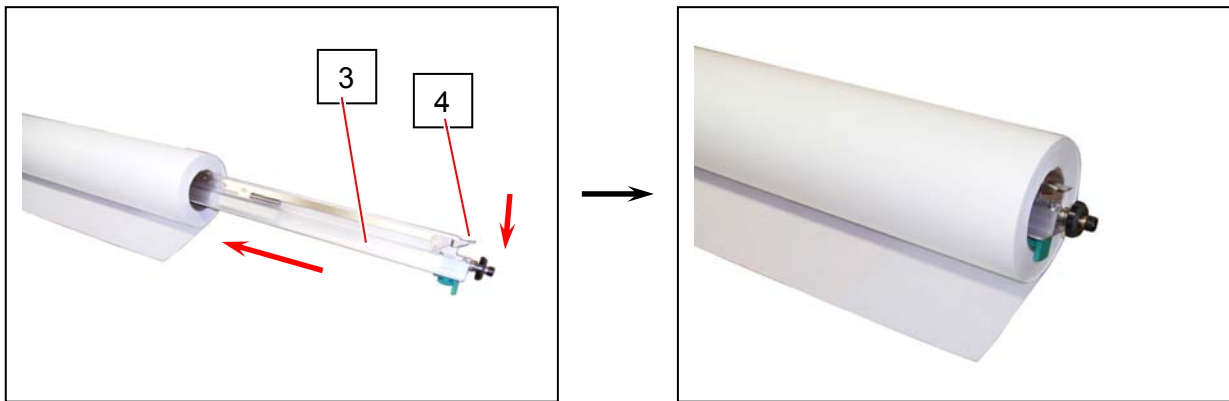

**! NOTE**

- (1) Be careful of the winding direction of roll paper at this time.

- (2) Try to rotate the Roll Spool after inserting to the roll paper to check whether or not it firmly holds the roll paper.



Move up the Lever (4) if the paper is not held firmly.  
A paper jam may occur if it is not held firmly.

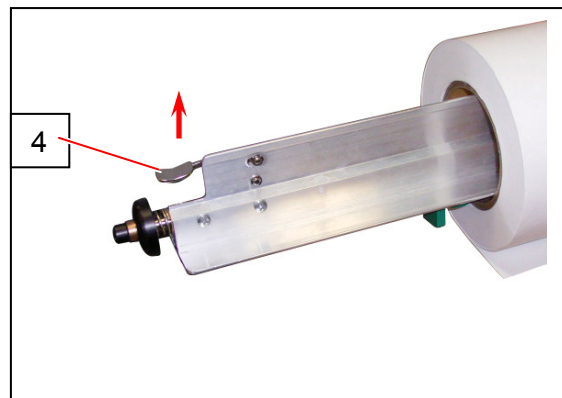

6. Install the Roll Spool (3) with new roll paper to the Roll Deck.

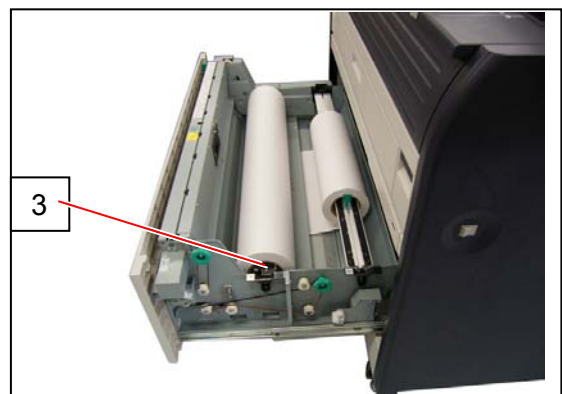

7. Insert the leading edge of roll paper under the Guide Plate (9) until the edge touches the feeding roller. Then rotate the Paper Feeding Knob (10) clockwise so that the feeding rollers catch the roll paper.

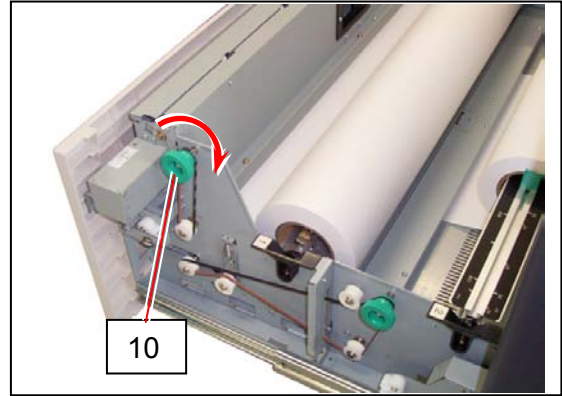
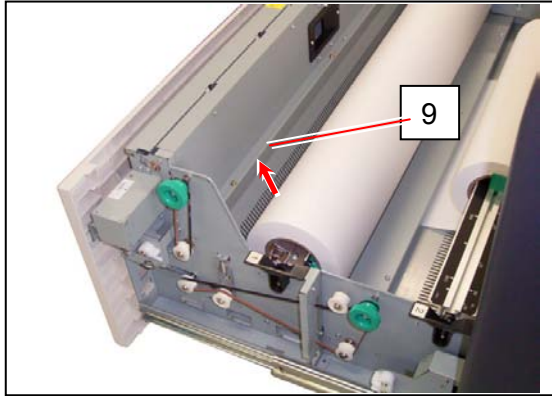

**NOTE**

In case of Roll 2, rotate the Paper Feeding Knob of rear side (11).

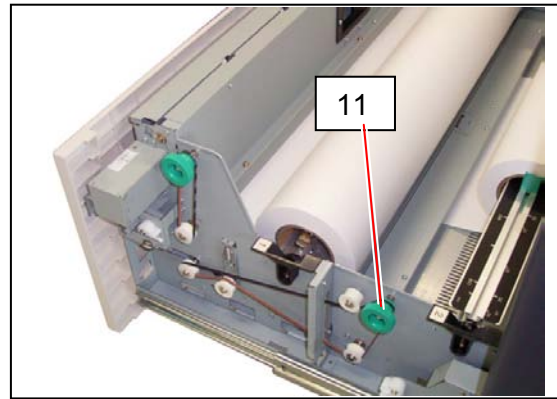

8. When the feeding rollers catch the paper, hold and pull the dent part (12) to the arrow direction to open the paper guide, and rotate the Paper Feeding Knob (10) until the leading edge comes out from the slit about 10cm.

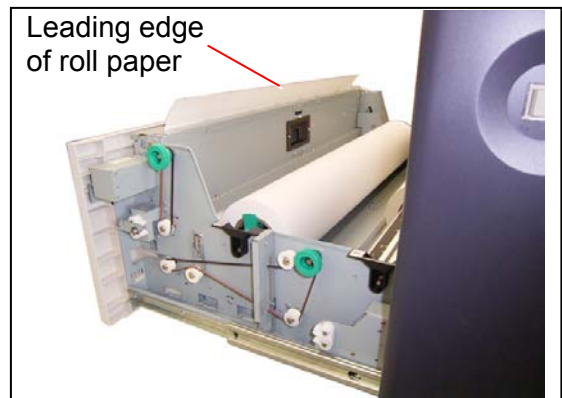
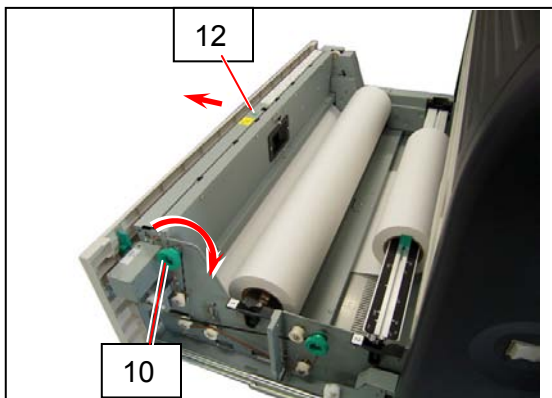



9. Slide the Cutter Knob (12) fully from one side to another side to cut the leading edge. Remove the paper portion after cutting.

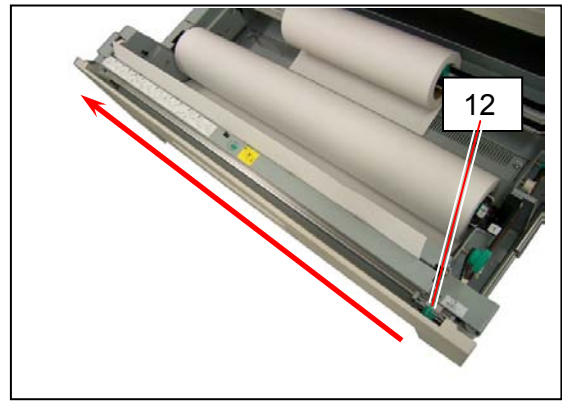

**! NOTE**

Slide the Cutter Knob completely until stopped at the end, or a paper jam occurs.

10. Rewind the roll paper a little to place the leading edge as the following photo.

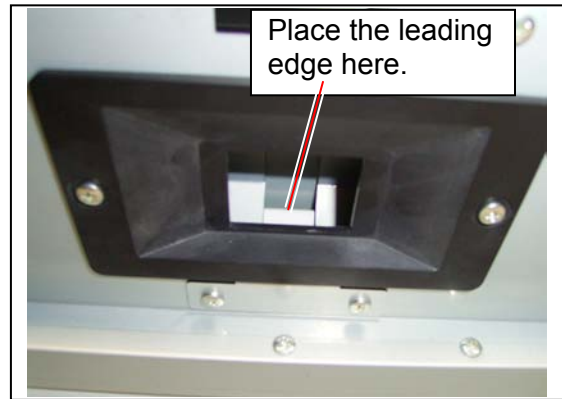
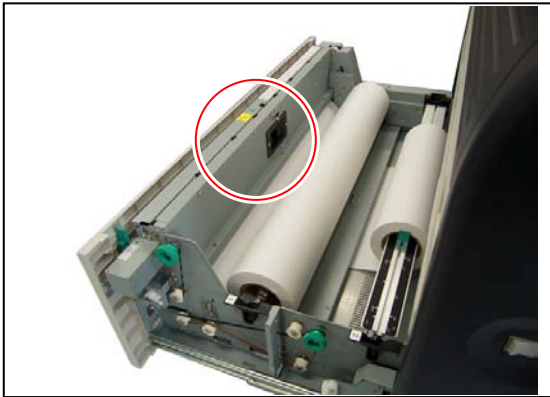

11. Close the Roll Deck (2) finally.



**! NOTE**

Make sure to close the Roll Deck firmly until locked at the correct position. A paper jam may occur if not locked firmly.

## 2. 4 Replacement of Toner Cartridge

1. Open the Toner Hatch (Original Table) (1).

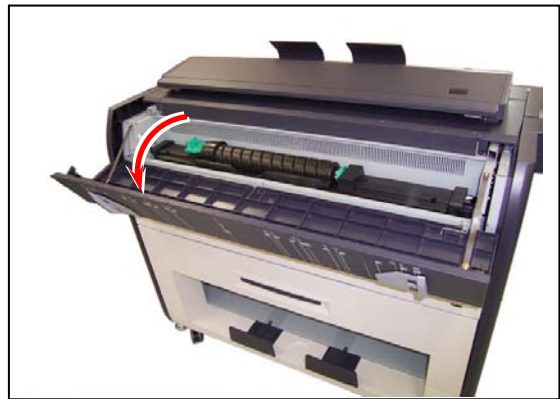

2. Slide the green Lever (2) to the right to unlock the Toner Cartridge.  
(Lever (2) is held automatically.)

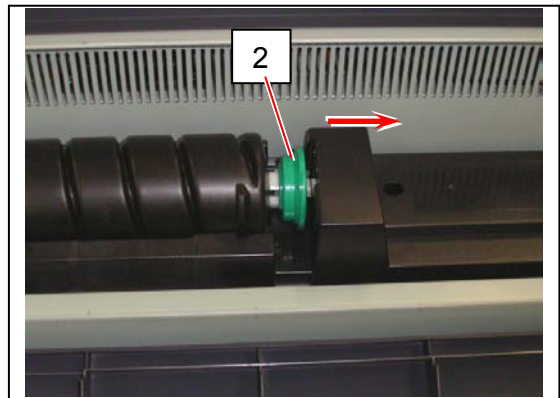

- Pressing down the Cartridge Lock Lever (3), rotate the body (4) of cartridge to the arrow direction some revolutions until it stops.  
(You can close the toner supplying hole of the cartridge firmly by this treatment.)

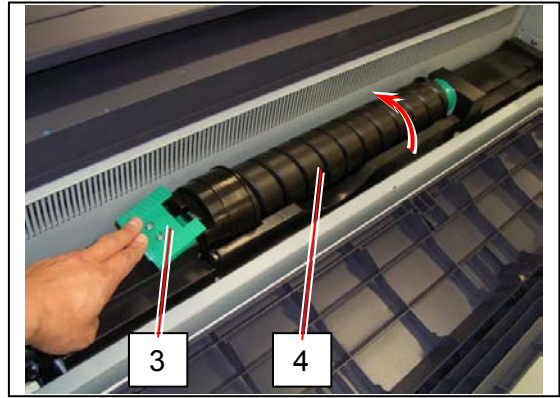

**! NOTE**

The toner may drop from the toner supplying hole, and it may scattered into the machine or on the floor if you remove the Toner Cartridge without closing the toner supplying hole (5).

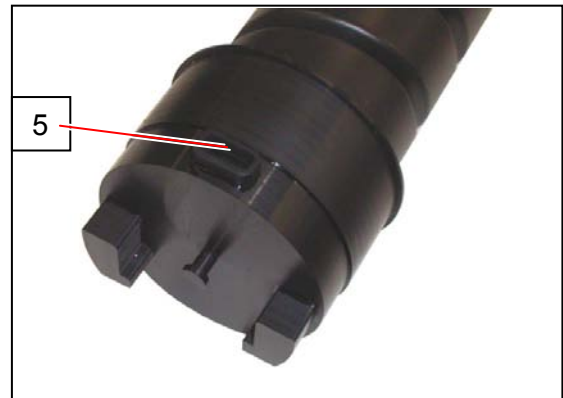

- Pressing down the Cartridge Lock Lever (3), bring up the left side of the Toner Cartridge first, and then remove the whole cartridge from the machine.

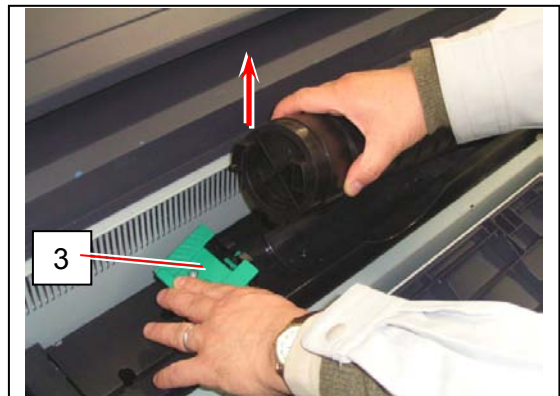

5. Shake the new Toner Cartridge several times left and right to make the toner smooth.



6. Pressing down the Cartridge Lock Lever (3), fit the pin (6) on the left side of cartridge to the groove (7) on the machine side.

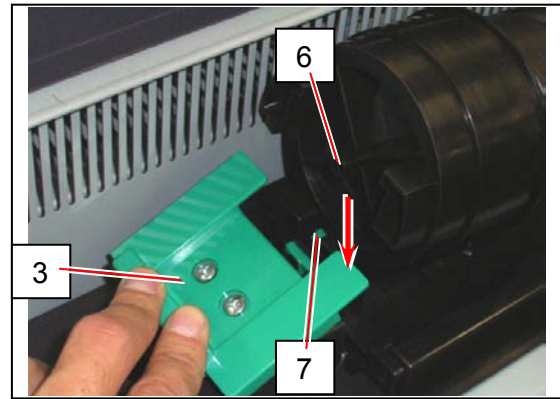

**! NOTE**

Confirm that the Cartridge Lock Lever (3) firmly locks the Toner Cartridge at the correct position. (It must be at a level position.)

Good

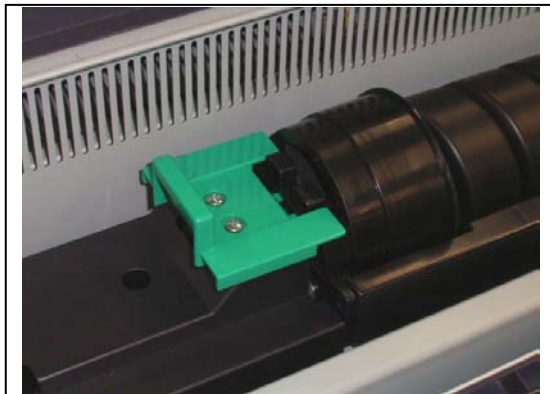

No good

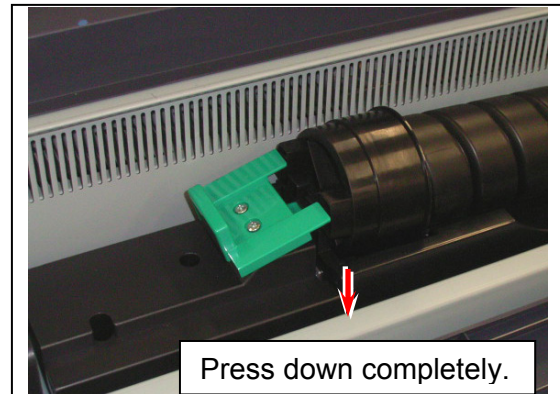



7. Rotate the body (4) of the cartridge to the arrow direction some revolutions to open the toner supplying hole.  
(You may feel tight when rotating the body (4).)

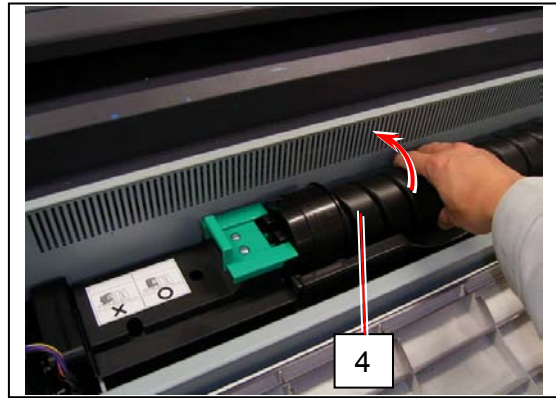

**! NOTE**

- (1) Confirm that the projection (8) is fitted into the notch (9).

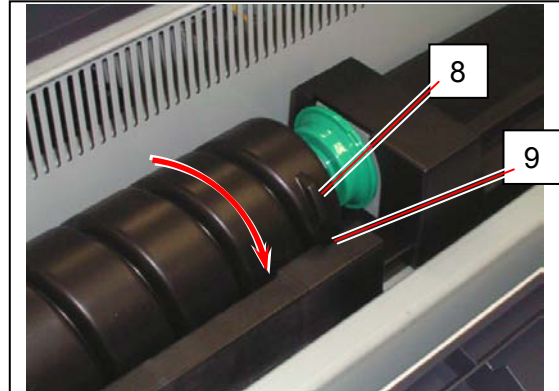

- (2) The Lever (2) may not lock the cartridge at this point of time, as it rotates and locks the cartridge automatically when Toner Hatch (Original Table) is closed.

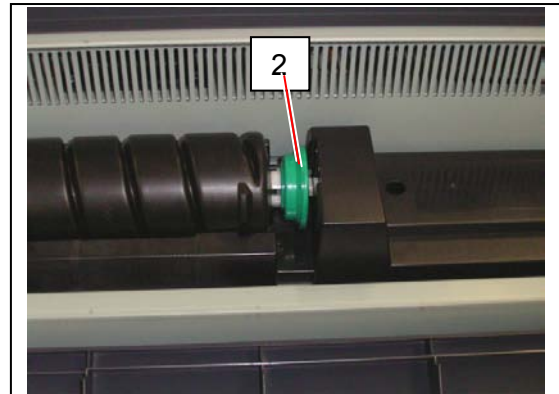

8. Close the Toner Hatch (Original Table) (1) finally.

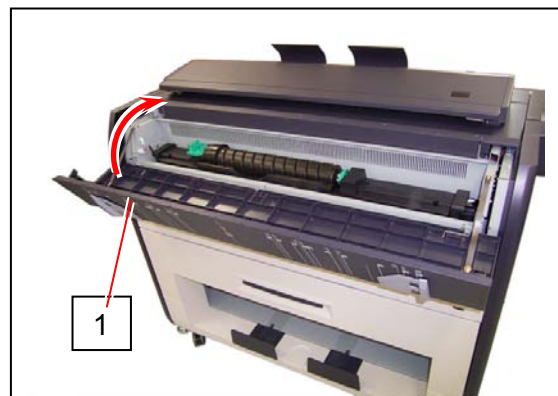

## 2. 5 Set of Cut Sheet Paper to the Bypass Feeder

---

1. Open the Bypass Feeder (1).

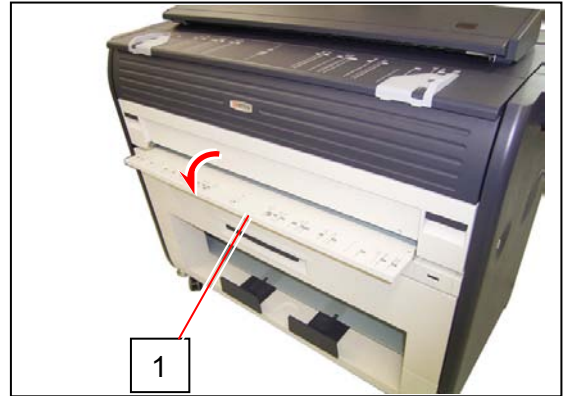

2. Put the cut sheet paper on the table along with the concerning size mark, and then insert it into the Bypass Feeder.  
When the paper touches the feeding roller, the machine automatically carries and sets the paper at the proper position.



## 2. 6 Copying

1. Move the position of the Original Guides (1) according to the width of original.



2. Put the original on the Original Table with face up. Insert it under the Scanner Unit along with the original Guides. When the leading edge touches the original feeding roller, the machine automatically carries the original to scan its image.



Scan starts automatically.

### NOTE

- (1) You need to press the Start Key on the Operation Panel to start copying if the Auto Start is OFF.



Start Key

- (2) If the original is curled "up", stretch the original well to make it be out of curl before setting to the scanner.

## 2. 7 Emergent Stop of Scan or Copy

Press the Emergent Stop Button (1) on the Scanner Unit if you will stop scanning or copying emergently in the middle.



### NOTE

The original is stopped at the time you press the Emergent Stop Button.  
The printing paper is cut at the same time and it is ejected.



## 2. 8 Dehumidifying the Roll Paper (Option)

If the roll paper is humidified, it may cause several kinds of poor quality. Poor quality you will experience most will be “crease of paper” and “void of image”.

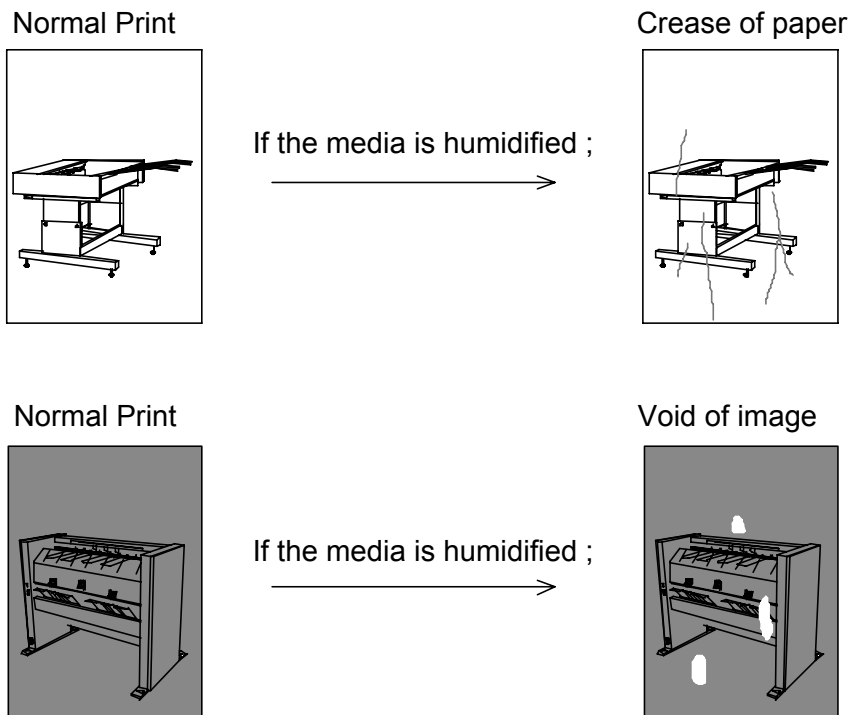

Turn on the Dehumidify Heater if the room air is so humidified (higher than 65%) to prevent the above kinds of poor quality. You may be able to fix the above kinds of problem.

### ! NOTE

The machine is not equipped with the Dehumidify Heater initially as it is an optional part. Purchase the Dehumidify Heater separately and install to the machine if necessary. Ask to the service personnel for the detail.

To turn on the Dehumidify Heater, press the H side of the Dehumidify Heater Switch on the back of the machine. (Press its L side to turn off.)

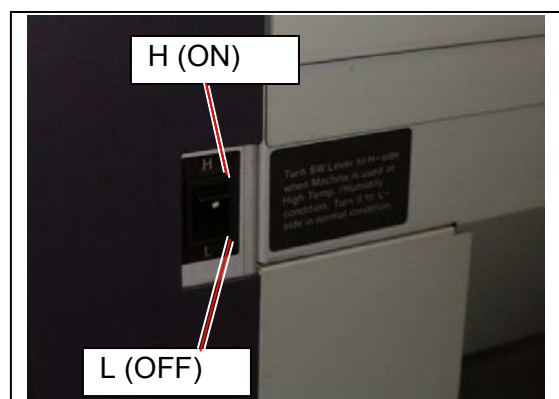

Dehumidify Heater Switch

# Chapter 3

## Error Correction

	Page
<b>3.1 Operator Call Errors</b> .....	3- 2
3.1.1 Paper jam .....	3- 2
3.1.1.1 Paper jam in the Roll Deck. Set the roll paper correctly. ....	3- 2
3.1.1.2 Paper jam in the bypass feeder. Remove the paper. ....	3- 5
3.1.1.3 Paper jam in internal area. Open the cover, and remove the paper. ....	3- 6
3.1.1.4 Paper jam in exit area. Open the cover, and remove the paper. ....	3- 8
3.1.1.5 Original Jam. Open the cover, and remove the original. ....	3- 11
3.1.2 Open errors .....	3- 12
3.1.2.1 Cover is open. Close the Cover. or Printer is starting up. ....	3- 12
3.1.2.2 Roll Deck is open. Close the Roll Deck. ....	3- 14
3.1.2.3 Close the scanner cover. ....	3- 15
3.1.3 Other messages .....	3- 16
3.1.3.1 Set XX roll paper to the Roll Deck. ....	3- 16
3.1.3.2 Set a paper to the bypass feeder. ....	3- 16
3.1.3.3 Toner empty. Replace the toner cartridge. ....	3- 17
3.1.3.4 In Warm Sleep Mode .....	3- 17
3.1.3.5 In Power Save Mode .....	3- 18
<b>3.2 Service Call Errors</b> .....	3- 19

# 3. 1 Operator Call Errors

---

## 3. 1. 1 Paper jam

When a paper jam occurred, any of the following messages will be displayed.

- Paper jam in paper the Roll Deck. Set the roll paper correctly.
- Paper jam in the bypass feeder. Remove the paper.
- Paper jam in internal area. Open the cover, and remove the paper.
- Paper jam in exit area. Open the cover, and remove the paper.
- Original Jam. Open the cover, and remove the original.

### 3. 1. 1. 1 Paper jam in the Roll Deck. Set the roll paper correctly.

“Paper jam in the Roll Deck” is displayed when the roll paper is mis-fed in the Roll Deck.

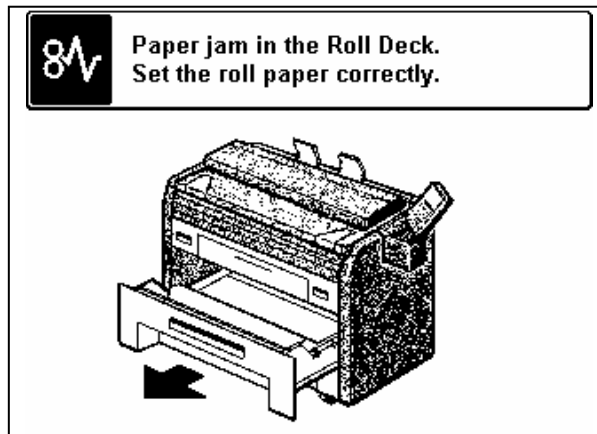

1. Open the Roll Deck, and then rewind the roll paper.



2. Insert the leading edge of roll paper under the under the Guide Plate (1) until the edge touches the feeding roller.  
Rotate the Paper Feeding Knob (2) clockwise so that the feeding rollers catch the roll paper.

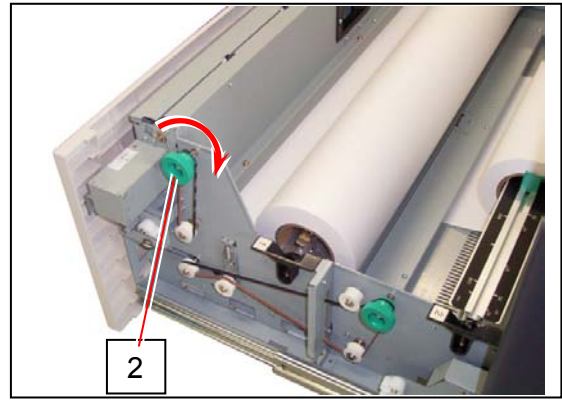
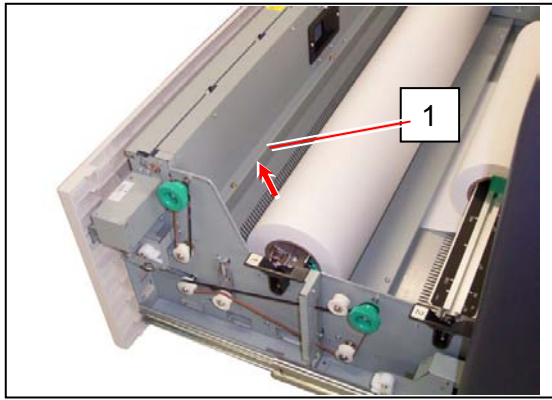

### **NOTE**

- (1) If the leading edge is extremely torn or folded, cut it off with a cutter or scissors.
- (2) Rotate the Paper Feeding Knob of rear side (3) for the Roll 2.

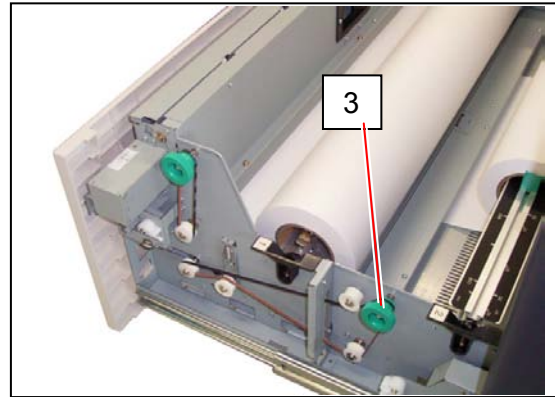

3. When the feeding rollers catch the paper, hold and pull the dent part (4) to the arrow direction to open the paper guide, and rotate the Paper Feeding Knob (2) until the leading edge comes out from the slit about 10cm.

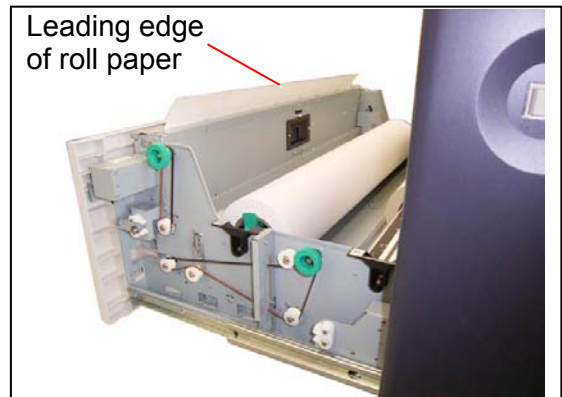
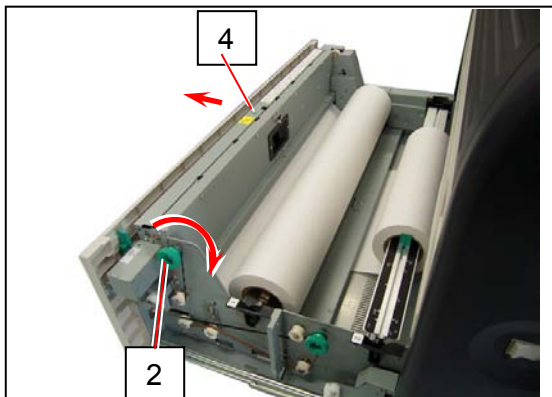

- Slide the Cutter Knob (5) fully from one side to another side to cut the leading edge.  
Remove the paper portion after cutting.

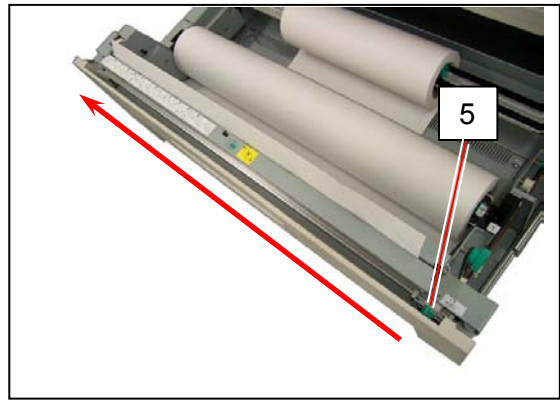

**! NOTE**

Slide the Cutter Knob completely until stopped at the end, or a paper jam occurs.

- Rewind the roll paper a little to place the leading edge as the following photo.

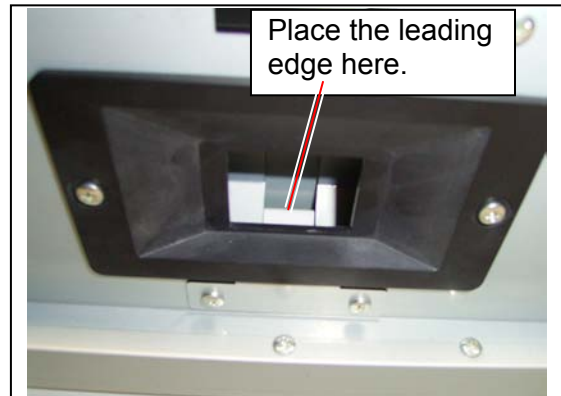

- Close the Roll Deck finally.



**! NOTE**

Make sure to close the Roll Deck firmly until locked at the correct position.  
A paper jam may occur if not locked firmly.



### 3. 1. 1. 2 Paper jam in the bypass feeder. Remove the paper.

“Paper jam in the bypass feeder” is displayed when the cut sheet paper is mis-fed in the Bypass Feeder.

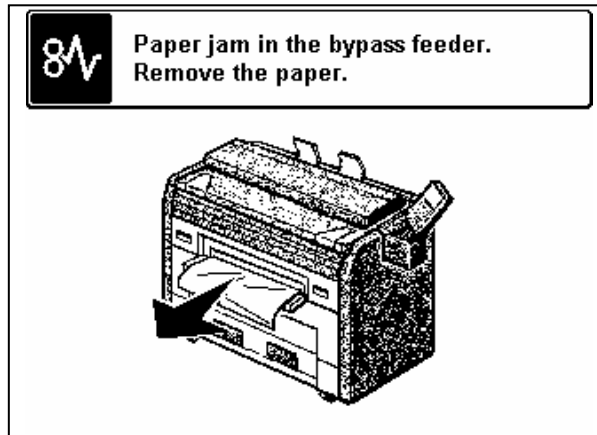

1. Pull up the Engine Unit Open Levers (1) to open the Engine Unit.

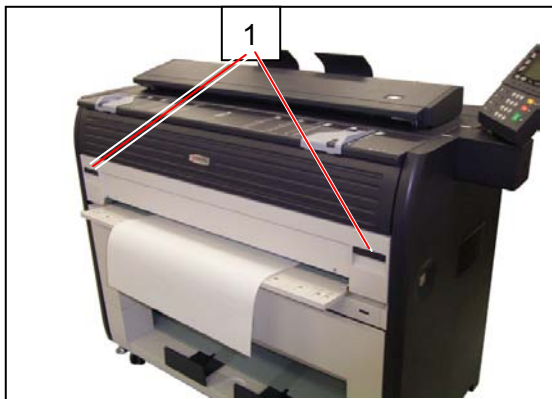

2. Remove the paper just pulling it frontward.



3. Close the Engine Unit.



### 3. 1. 1. 3 Paper jam in internal area. Open the cover, and remove the paper.

“Paper jam in internal area” is displayed when the paper is mis-fed in internal area of the machine.

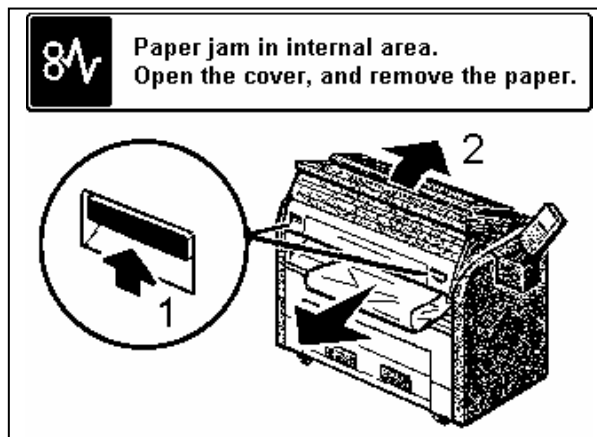

1. Pull up the Engine Unit Open Levers (1) to open the Engine Unit.



2. Remove the mi-fed paper (2).



3. Close the Engine Unit firmly.



**! NOTE**

Make sure to close the Engine Unit firmly until locked at the correct position.



### 3. 1. 1. 4 Paper jam in exit area. Open the cover, and remove the paper.

“Paper jam in exit area” is displayed when the paper is mis-fed in the exit area.

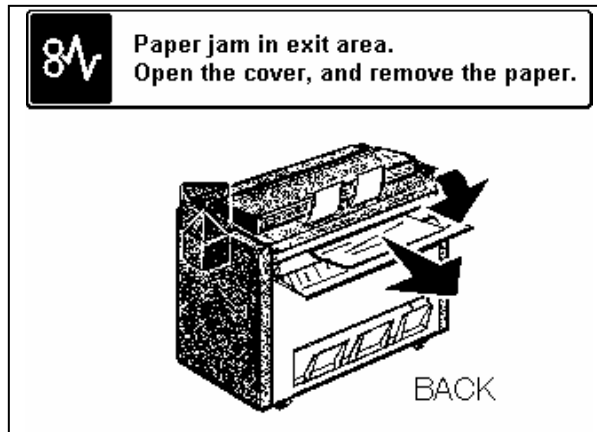

1. Pull up the Engine Unit Open Levers (1) to open the Engine Unit.

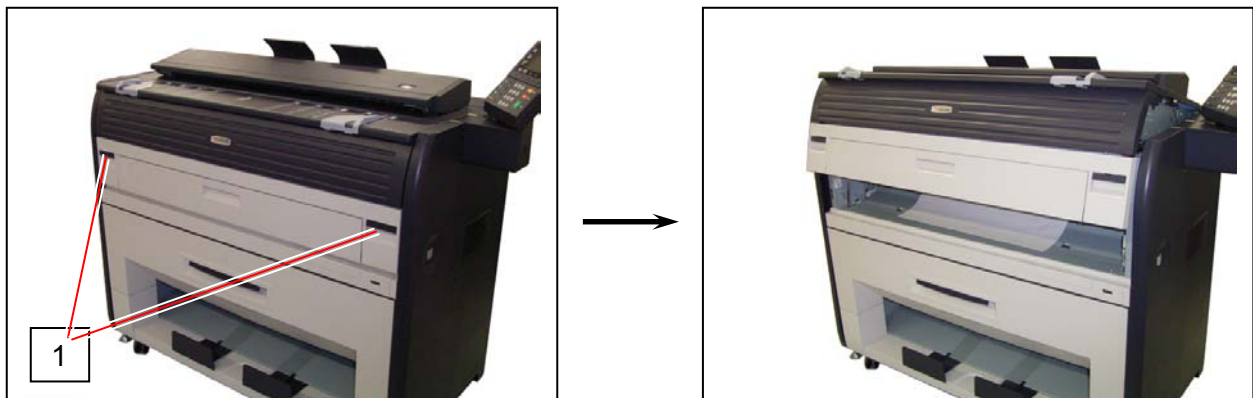

2. Check the position of the paper in the machine.

If the paper is accessible from the front side as the right photo, go to the following procedure 3.



If the paper is impossible to access from the front side because the end of paper is deep in the machine as the following photo, go to the following procedure 4.



3. Simply pull out the paper to the front side when accessible from the front side.



4. If the paper is not accessible from the front side, hold both handles (2) and open the Exit Cover (3).

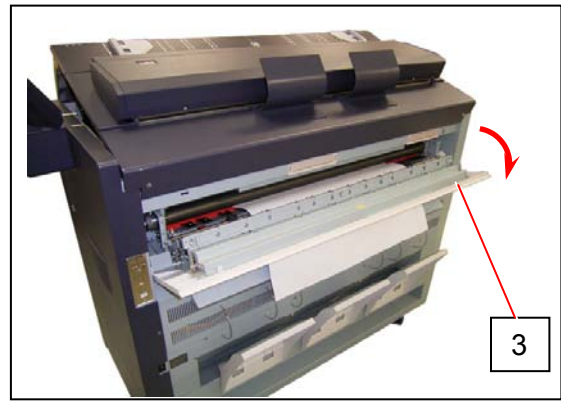
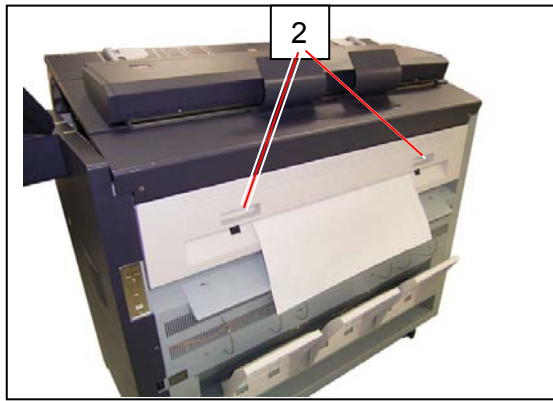

5. Remove the paper pulling to the rear side.



### **WARNING**

Do not touch any part in the Exit Cover because some parts are extremely hot, or you will be burnt.

Also be careful not to get burnt when you touch the printing paper as it may be very hot.

### **NOTE**

Toner may be sticking on the Fuser Roller after removing the mis-fed paper.  
This toner may be fused onto the next printing paper.

### 3. 1. 1. 5 Original Jam. Open the cover, and remove the original.

“Original jam” is displayed when the original is mis-fed in the Scanner Unit.

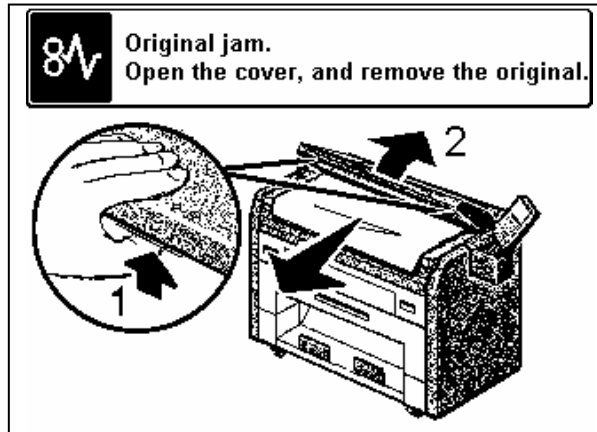

1. Open the Scanner Unit pulling up the Levers (1), and then remove the original.



2. Move the Scanner Unit a little to the rear side to unlock, and then close it.



## 3. 1. 2 Open errors

When any cover or unit of the machine is open, any of the following messages will be displayed.

- Cover is opened. Close the Cover. or Printer is starting up.
- Roll Deck is open. Close the Roll Deck.
- Close the scanner cover.

### 3. 1. 2. 1 Cover is open. Close the Cover. or Printer is starting up.

“Cover is open” is displayed when either Engine Unit or Toner Hatch (Original Table) is open. This message is also displayed when the machine is in the middle of starting up.

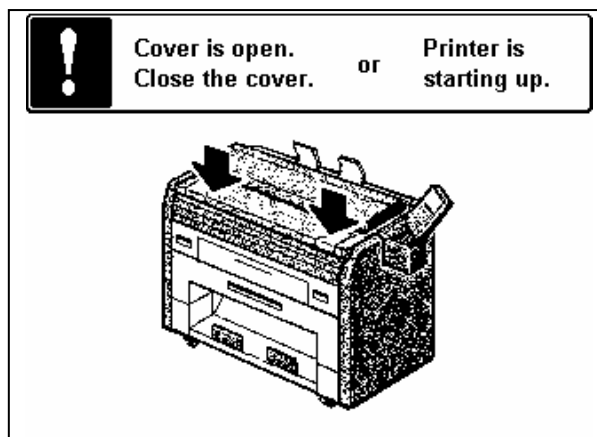

1. Check if the Engine Unit is closed (locked) firmly. If not, close it firmly.

#### NOTE

The Engine Unit may be opened slightly (unlocked) even if it looks closed firmly.



2. Check if the Toner Hatch (Original Table) is closed firmly.  
If not, close it firmly.

**! NOTE**

The Toner Hatch (Original Table) may be opened slightly even if it looks closed firmly.

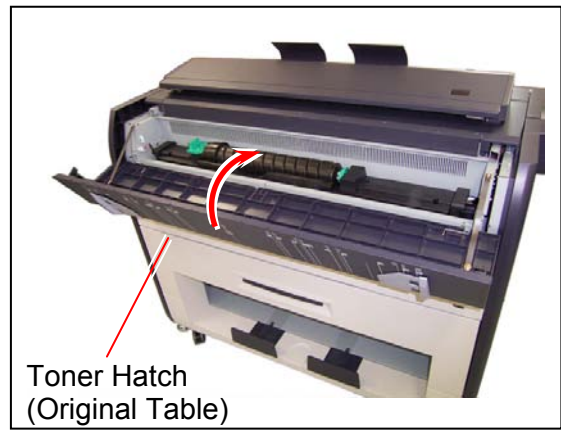

3. If the same error message is displayed although both Engine Unit and Toner Hatch (Original Table) are closed firmly, the machine is in the start up process.  
Wait for a while until the error message disappears automatically.



### 3. 1. 2. 2 Roll Deck is open. Close the Roll Deck.

“Roll Deck is open” is displayed when the Roll Deck is open.

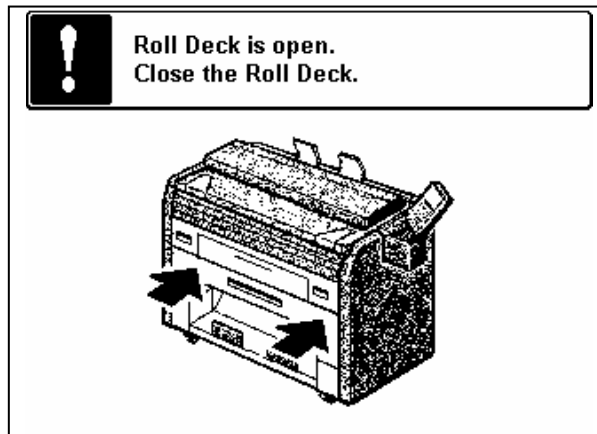

1. Check if the Roll Deck is closed firmly. If not, close it firmly.



#### **NOTE**

The Roll Deck may be opened slightly even if it looks closed firmly.

### 3. 1. 2. 3 Close the scanner cover.

“Close the scanner cover” is displayed when the Scanner Unit is open.

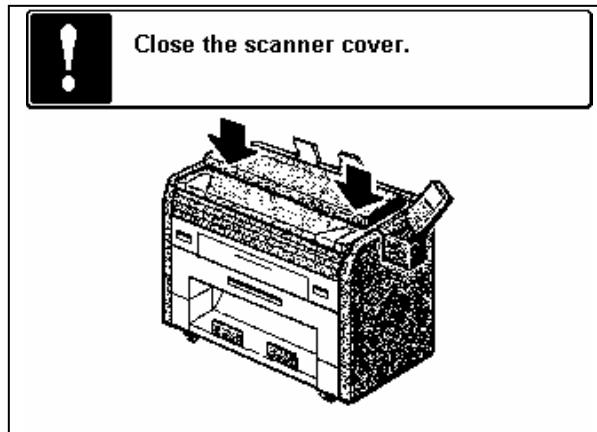

1. Check if the Scanner Unit is closed firmly.  
If not, close it firmly.

#### **NOTE**

The Scanner Unit may be opened slightly even if it looks closed firmly.





### 3. 1. 3 Other messages

The following messages will be displayed according to the situation.

- Set XX roll paper to the Roll Deck.
- Set a paper to the bypass feeder.
- Toner empty. Replace the toner cartridge.
- In Warm Sleep Mode
- In Power Save Mode

#### 3. 1. 3. 1 Set XX roll paper to the Roll Deck.

When “Set XX roll paper to the Roll Deck” is displayed, set the roll paper of required size to the Roll Deck.

(“XX” stands for the paper width.)

Refer to [2.3 Replacement of Roll Paper] on page 2-4 for the way to set the roll paper.

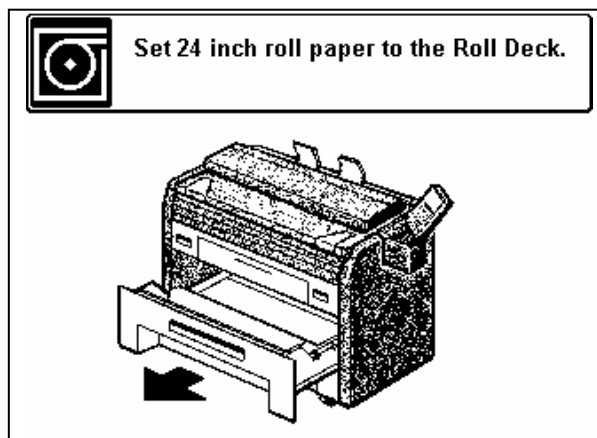

#### 3. 1. 3. 2 Set a paper to the bypass feeder.

When “Set a paper to the bypass feeder” is displayed, set a cut sheet paper to the Bypass Feeder. Refer to [2.5 Set of Cut Sheet Paper to the Bypass Feeder] on page 2-13 for the way to set the cut sheet paper.

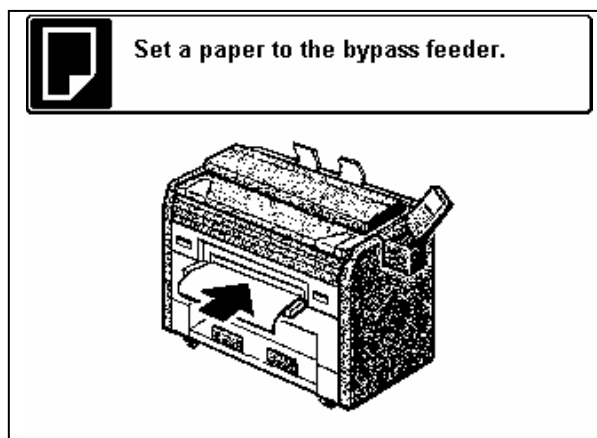

### 3. 1. 3. 3 Toner empty. Replace the toner cartridge.

When “Toner empty.” is displayed, replace the Toner Cartridge with the new one. Refer to [2.4 Replacement of Toner Cartridge] on page 2-9 for the way to replace the Toner Cartridge.

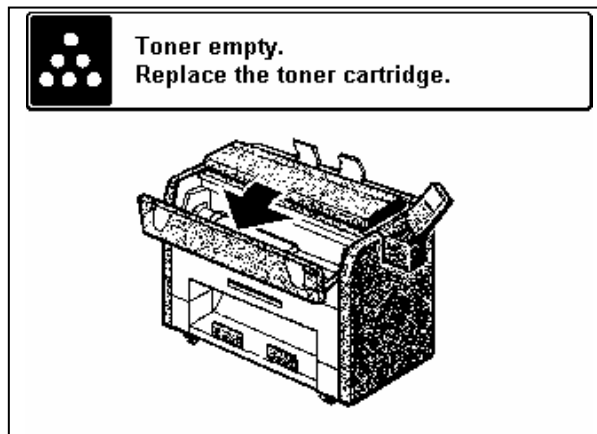

### 3. 1. 3. 4 In Warm Sleep Mode

When “In Warm Sleep Mode.” is displayed, KM-3650w is in the Warm Sleep Mode to save the power consumption.

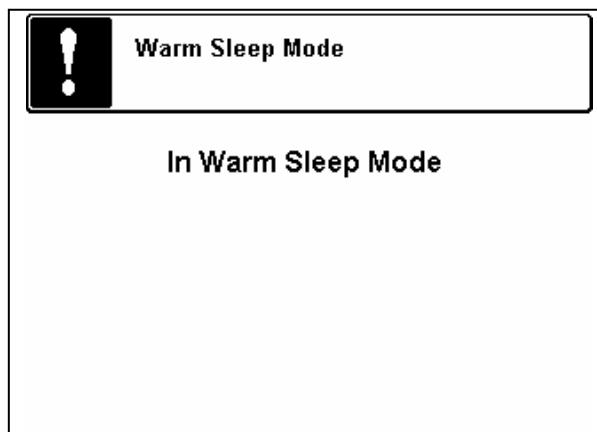

#### Reference

- (1) The Warm Sleep Mode works automatically if you make no operation for the time specified in advance.  
The temperature maintained on the Fuser Unit is fallen down great degrees to save the power consumption.
- (2) The Warm Sleep Mode will be cancelled by the following 3 ways.
  - Making a print from the network
  - Inserting an original to the scanner
  - Pressing any key on the Operation PanelNote that it takes some minutes to recover from the Warm Sleep Mode as the temperature of Fuser Unit must be raised again.  
(Print starts when the machine gets ready.)

### 3. 1. 3. 5 In Power Save Mode

When “In Power Save Mode.” is displayed, KM-3650w is in the Power Save Mode to save the power consumption.

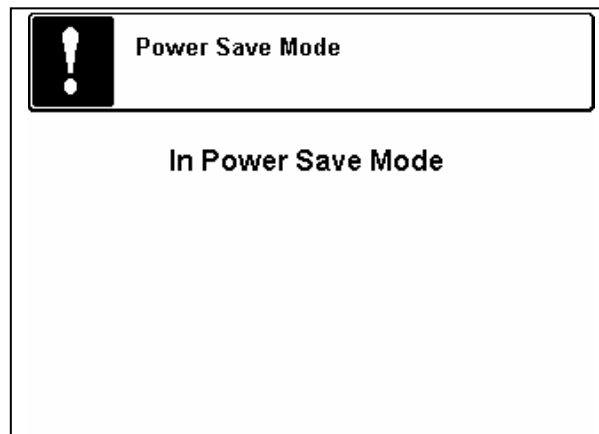

#### Reference

- (1) The Power Save Mode works automatically if you make no operation for the time specified in advance.  
The machine ceases controlling the temperature of Fuser Unit completely to save the power consumption. (Power Save Mode can save more power than Warm Sleep Mode.)
- (2) The Power Save Mode will be cancelled by the following 3 ways.
  - Making a print from the network
  - Inserting an original to the scanner
  - Pressing any key on the Operation PanelNote that it takes some minutes to recover from the Power Save Mode as the temperature of Fuser Unit must be raised again.  
(Print starts when the machine gets ready.)

## 3.2 Service Call Errors

---

You will note an error message “A significant error occurred. Call the service” on the operation panel if the machine has the fatal error.

At this time one of the following sub messages is displayed also.

Counter Error  
Cutter Error  
Developer Motor Error  
FPGA Error  
Fuser Low temp  
Fuser Motor Error  
Fuser Over temp  
HV Charger Error  
License Key Error  
Main Motor Error

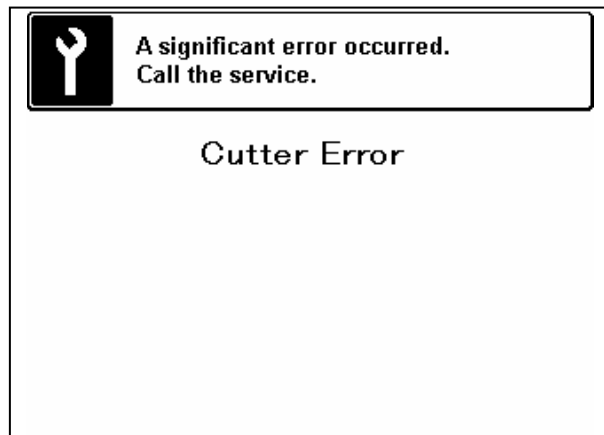

**PLEASE CALL YOUR TRAINED SERVICE PERSONNEL TO RESOLVE THESE ERRORS.**

If any of the above errors is displayed:

1. Turn off the machine, wait approximately 30 seconds, and then turn on the machine again.
2. If the same error message is displayed, turn off the machine, and then unplug the machine from the wall outlet.  
Call your service personnel.

# Chapter 4

## Maintenance

	Page
<b>4. 1   Cleaning of Each Part</b> .....	4- 2
4. 1. 1   Scanner Unit .....	4- 2
4. 1. 2   Print Engine .....	4- 4
4. 1. 3   Operation Panel .....	4- 6

# 4. 1 Cleaning of Each Part

## 4. 1. 1 Scanner Unit

Clean each Scan Glass, Feeding Rollers and Guide Plates once per a week, as the scan/copy image may become defective if these parts are dirty.

1. Confirm that the machine is turned off.
2. Open the Scanner Unit pulling up the Levers (1).



3. Wipe each Scan Glass (2) and Feeding Rollers (3) with a soft cloth. Use the neutral detergent mixed with 50% of water as the cleaner.

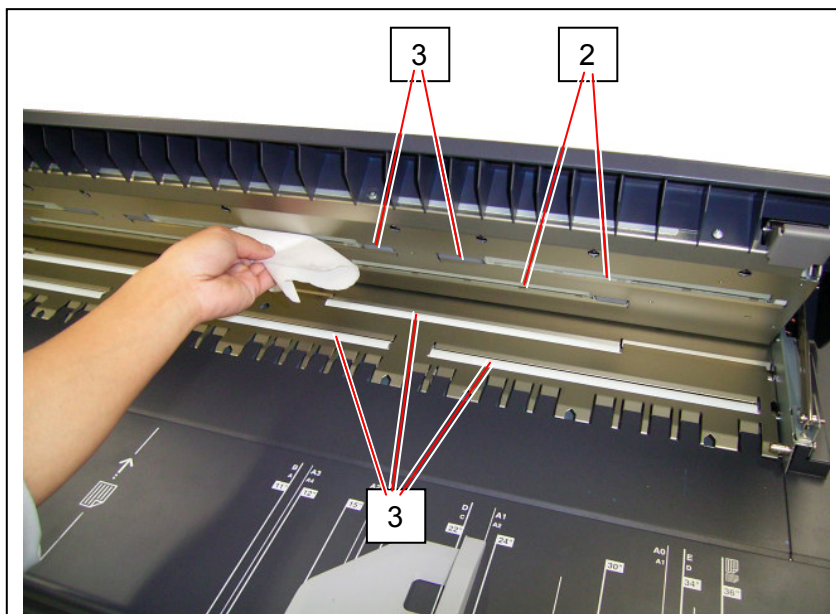

### **!** NOTE

Do not use organic solvent, glass cleaner and anti-static spray for the cleaning.

4. Wipe both the Upper Guide Plate (4) and the Lower Guide Plate (5) with a soft dry cloth.

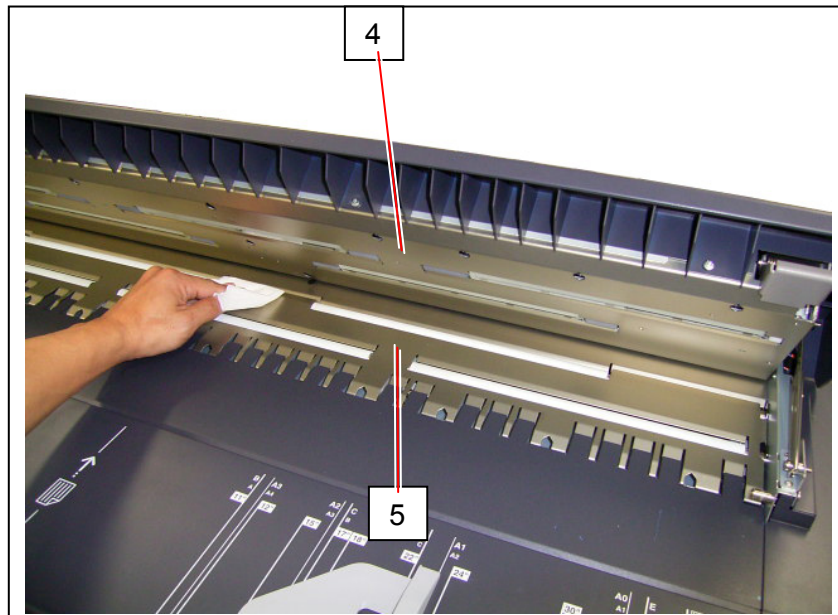

5. Move the Scanner Unit a little to the rear side to unlock, and then close it.



## 4. 1. 2 Print Engine

Clean each Guide Film and Guide Plate once per a week, as the toner or paper dust may accumulates on such part which may result in a defective print image.

1. Confirm that the machine is turned off.
2. Open the Engine Unit pulling up the Engine Unit Open Levers (1).



3. Wipe each Guide Film (2) and Guide Plate (3) with a soft dry cloth to remove the toner or paper dust.

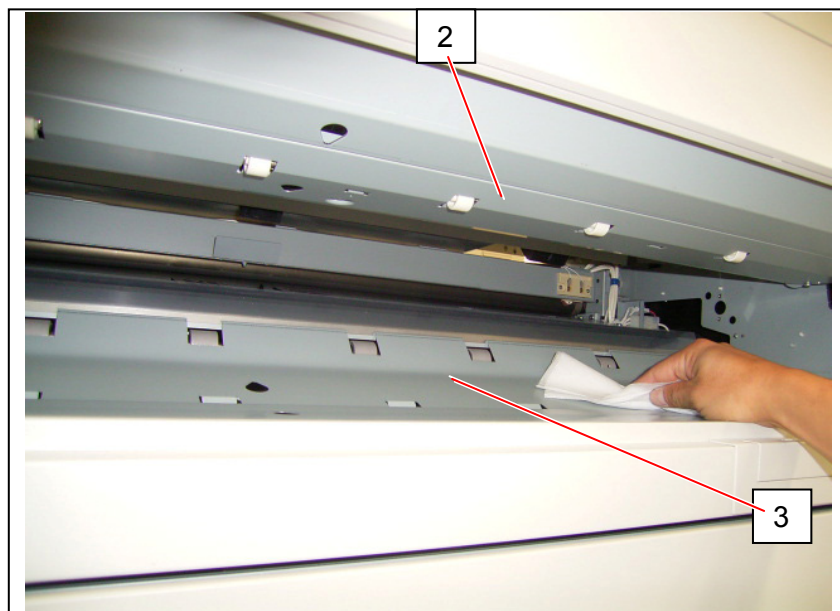



**NOTE**

- (1) Photoconductive Drum (large green cylinder) right above the Guide Film.  
You need to replace the Drum if damaged, as it is a very important part in creating the print image.

Be careful about the following matters.

- a.) Do not touch the drum.  
If you put your fingermark or oil on the Drum, it will cause for the defective image.
- b.) Take off such metal accessories as watch or ring.  
You will have to replace the Drum if you damage the Drum scratching with such accessories.
- c.) Do not leave the Upper Unit open for more than 10 minutes as the Drum is very sensitive to light. (Direct sunlight is very harmful.)

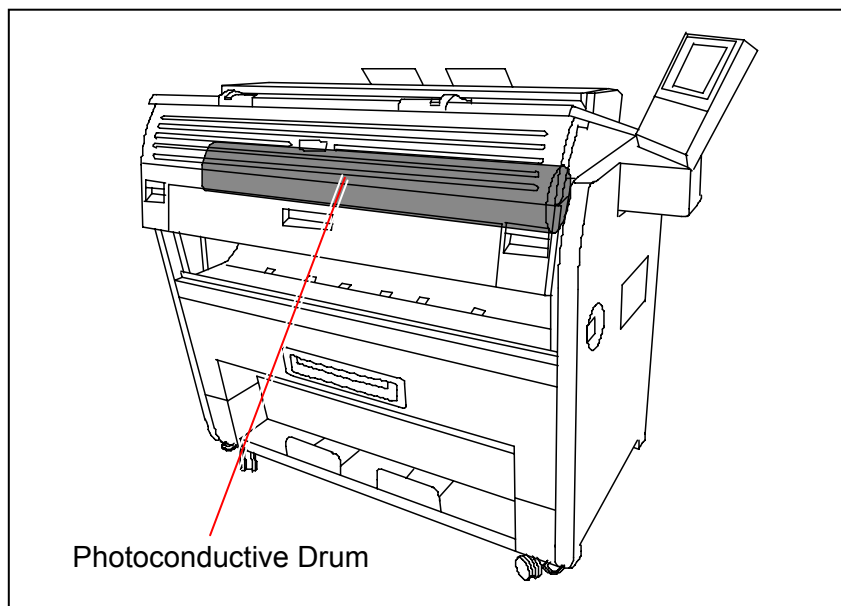

- (2) Do not use water, organic solvent and alcohol for the cleaning.

4. Close the Engine Unit.



## 4. 1. 3 Operation Panel

Clean the Operation Panel once per a week.

1. Confirm that the machine is turned off.
2. Wipe the Operation Panel with a dry cloth.



### **!** NOTE

Do not use water, alcohol, organic solvent and glass cleaner for the cleaning.

**For best results and machine performance, we recommend that you use only our original supplies for your products.**



## KYOCERA MITA AMERICA, INC.

### **Headquarters:**

225 Sand Road,  
Fairfield, New Jersey 07004-0008  
TEL : (973) 808-8444  
FAX : (973) 882-6000

### **New York Branch:**

1410 Broadway 23rd floor  
New York, NY 10018  
TEL : (917) 286-5400  
FAX : (917) 286-5402

### **Northeastern Region:**

225 Sand Road,  
Fairfield, New Jersey 07004-0008  
TEL : (973) 808-8444  
FAX : (973) 882-4401

### **Midwestern Region:**

201 Hansen Court Suite 119  
Wood Dale, Illinois 60191  
TEL : (630) 238-9982  
FAX : (630) 238-9487

### **Western Region:**

14101 Alton Parkway,  
Irvine, California 92618-7006  
TEL : (949) 457-9000  
FAX : (949) 457-9119

### **Southeastern Region:**

1500 Oakbrook Drive,  
Norcross, Georgia 30093  
TEL : (770) 729-9786  
FAX : (770) 729-9873

### **Southwestern Region:**

2825 West Story Road,  
Irving, Texas 75038-5299  
TEL : (972) 550-8987  
FAX : (972) 252-9786

### **National Operation Center & National Training Center:**

2825 West Story Road,  
Irving, Texas 75038-5299  
TEL : (972) 659-0055  
FAX : (972) 570-5816

### **Latin America Division:**

8240 N.W. 52nd. Terrace Dawson Building,  
Suite 108 Miami, Florida 33166  
TEL : (305) 421-6640  
FAX : (305) 421-6666

## KYOCERA MITA CANADA, LTD.

6120 Kestrel Road, Mississauga,  
Ontario L5T 1S8, Canada  
TEL : (905) 670-4425  
FAX : (905) 670-8116

## KYOCERA MITA MEXICO, S.A. DE C.V.

Av. 16 de Septiembre #407  
Col. Santa Inés,  
Azcapotzalco México,  
D.F. 02130, México  
TEL : (55) 5383-2741  
FAX : (55) 5383-7804

## KYOCERA MITA EUROPE B.V.

Hoeksteen 40, 2132 MS Hoofddorp,  
The Netherlands  
Phone: +31.(0)20.654.0000  
Home page: <http://www.kyoceramita-europe.com>  
Email: [info@kyoceramita-europe.com](mailto:info@kyoceramita-europe.com)

KYOCERA MITA NEDERLAND B.V.  
Beechavenue 25, 1119RA SCHIPHOL-RIJK  
The Netherlands

Phone: +31-(0)20-5877200

KYOCERA MITA (UK) LTD.

8 Beacontree Plaza  
Gillette Way, Reading Berks RG2 0BS,  
UK

Phone: +44.(0)118.931.1500

KYOCERA MITA ITALIA S.P.A.

Via Verdi 89 / 91 20063 Cernusco sul Naviglio,  
(Milano), Italy

Phone: +39.02.92179.1

S.A. KYOCERA MITA BELGIUM N.V.

Hermesstraat 8A 1930 Zaventem,  
Belgium

Phone: +32.(0)2.720.9270

KYOCERA MITA FRANCE S.A.

Parc Les Algorithmes, Saint Aubin  
91194 GIF-SUR-YVETTE,  
France

Phone: +33.(0)1.6985.2600

KYOCERA MITA ESPAÑA S.A.

Edificio Kyocera, Avda de Manacor N. 2,  
Urb. Parque Rozas 28290 Las Rozas, Madrid,  
Spain

Phone: +34.(0)91.631.8392

KYOCERA MITA FINLAND OY

Kirvesmiehenkatu 4 00810 Helsinki,  
Finland

Phone: +358.(0)9.4780.5200

KYOCERA MITA (SCHWEIZ) AG

Industriestrasse 28, 8604 Volketswil,  
Switzerland

Phone: +41.(0)1.908.4949

KYOCERA MITA DEUTSCHLAND GMBH

Mollsfeld 12-40670 Meerbusch,  
Germany

Phone: +49.(0)2159.918.0

KYOCERA MITA GMBH AUSTRIA

Eduard-Kittenberger Gasse 95  
A-1230 Wien,  
Austria

Phone: +43.(0)1.86338.401

KYOCERA MITA SVENSKA AB

Vretenragen 2, 6tr 171 54 Solna,  
Sweden

Phone: +46.(0)8.546.550.00

KYOCERA MITA NORGE

Postboks 150 Oppsal, NO 0619 Oslo  
Olaf Helsetsvetvei 6, NO 0694 Oslo,  
Norway

Phone: +47.(0)22.62.73.00

KYOCERA MITA DANMARK A/S

Slotsmarken 11, 2 DK-2970 Hørsholm,  
Denmark

Phone: +45.7022.3880

KYOCERA MITA PORTUGAL LDA.

Rua do Centro Cultural, no 41 1700-106 Lisbon,  
Portugal

Phone: +351.(0)21.843.6780

KYOCERA MITA SOUTH AFRICA (PTY) LTD.

527 Kyalami Boulevard,  
Kyalami Business Park Midrand,  
South Africa

Phone: +27.(0)11.540.2600

## KYOCERA MITA AMERICA, INC.

Headquarters:

225 Sand Road,  
Fairfield, New Jersey 07004-0008,  
U.S.A.

Phone: (973) 808-8444

KYOCERA MITA AUSTRALIA PTY. LTD.

Level 3, 6-10 Talavera Road, North Ryde,  
N.S.W. 2113 Australia

Phone: (02) 9888-9999

KYOCERA MITA NEW ZEALAND LTD.

1-3 Parkhead Place, Albany  
P.O. Box 302 125 NHPC, Auckland,  
New Zealand

Phone: (09) 415-4517

KYOCERA MITA (THAILAND) CORP., LTD.

9/209 Ratchada-Prachachem Road,  
Bang Sue, Bangkok 10800, Thailand

Phone: (02) 586-0320

KYOCERA MITA SINGAPORE PTE LTD.

121 Genting Lane, 3rd Level,  
Singapore 349572

Phone: 67418733

KYOCERA MITA HONG KONG LIMITED

11/F., Mita Centre,  
552-566, Castle Peak Road,  
Tsuen Wan, New Territories,  
Hong Kong

Phone: 24297422

KYOCERA MITA TAIWAN Corporation.

7F-1~2, No.41, Lane 221, Gangchi Rd.  
Neihu District, Taipei, Taiwan, 114. R.O.C.

Phone: (02) 87511560

## KYOCERA MITA Corporation

2-28, 1-chome, Tamatsukuri, Chuo-ku  
Osaka 540-8585, Japan

Phone: (06) 6764-3555

<http://www.kyoceramita.com>

